

# electronics

radio, communication, industrial applications of electron tubes . . . engineering and manufacture

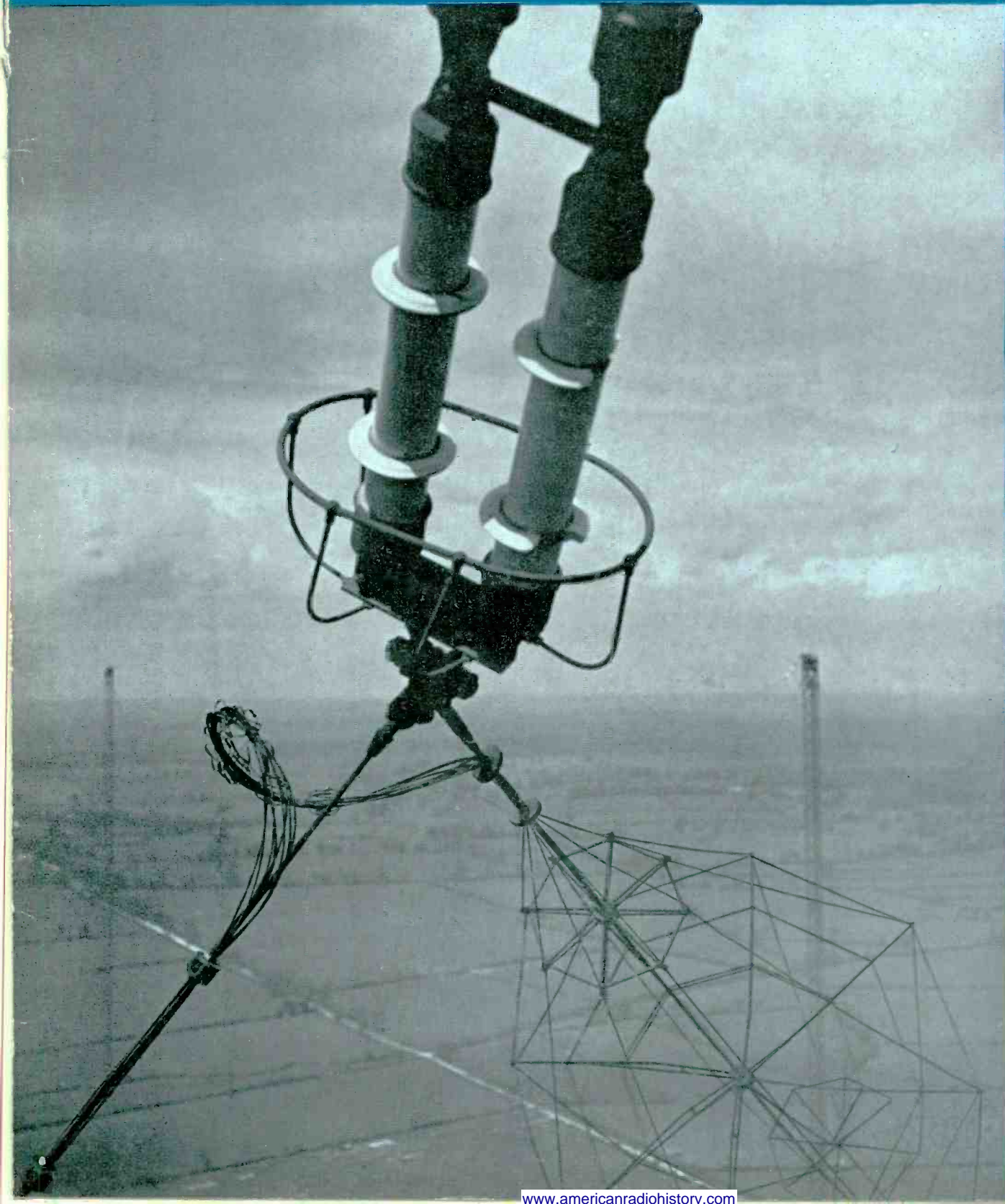

APRIL  
1938

Price  
50 Cents

McGRAW-HILL  
PUBLISHING  
COMPANY, INC.

"After 9740 hours on a daily 24 hour schedule... still show full emission and are perfectly satisfactory"

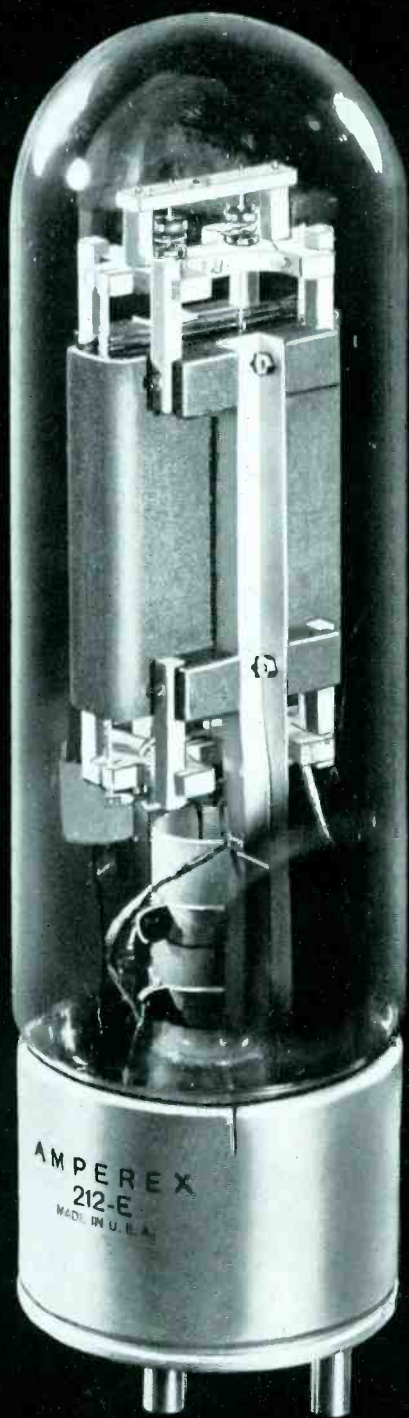

\$75



SERVING NEW YORK AND NEW JERSEY 24 HOURS A DAY  
501 MADISON AVENUE  
NEW YORK CITY, N. Y.

Amperex Electronic Products, Inc.  
Brooklyn, New York

Gentlemen:

You will be interested in knowing of the results of a recent test run on four Amperex type 212E vacuum tubes in our transmitter.

Two were removed at 6959 hours, and the two remaining in use show 7103 hours and 9740 hours respectively. The latter two tubes still show full emission and are perfectly satisfactory in operation as indicated by routine distortion measurements. Inasmuch as we operate on a twenty-four hour daily schedule, we are interested in obtaining the greatest possible tube life, consistent with good operation.

The results of the above test run indicate that we may expect much more economical operation in the future.

Very truly yours,

*M. J. Weiner*  
M. J. Weiner  
Chief Engineer

## 212-E

A.F. AMPLIFIER, MODULATOR, R.F. OSCILLATOR, AMPLIFIER

### CHARACTERISTICS

Filament voltage	14
Filament current	6
Average characteristics with plate potential of 1500 volts and grid bias of	-60
Plate resistance, ohms	1900
Mutual conductance, micromhos	8500
Maximum D.C. plate current, milliamperes	300

The AMPEREX 212-E is interchangeable with the WE 212-D or 212-E of any other make

**AMPEREX ELECTRONIC PRODUCTS, Inc.**  
79 WASHINGTON STREET  
BROOKLYN, NEW YORK

# electronics



RADIO . . . COMMUNICATION AND  
INDUSTRIAL APPLICATIONS OF  
ELECTRON TUBES . . . DESIGN . . .  
ENGINEERING . . . MANUFACTURE

HOWARD EHRLICH  
Executive Vice-President

H. W. MATEER  
Manager

KEITH HENNEY  
Editor

DONALD G. FINK  
Managing Editor

BEVERLY DUDLEY  
Associate Editor

HARRY PHILLIPS  
Art Director

ELECTRONICS, April, 1938, Vol. 11, No. 4.  
Published monthly, price 50c a copy. Subscription  
rates — United States and possessions, Canada,  
Mexico and Central American countries, \$5.00 a  
year. All other countries, \$8.00 a year or 24  
shillings. Entered as Second Class matter, August  
29, 1936, at Post Office, Albany, N. Y., under  
the Act of March 3, 1879.  
Branch Offices: 520 North Michigan Ave., Chicago;  
883 Mission St., San Francisco; Aldwych House,  
Aldwych, London, W. C. 2; Washington; Phila-  
delphia; Cleveland; Detroit; St. Louis; Boston;  
Atlanta, Ga.

Contents Copyright, 1938, by  
McGraw-Hill Publishing Company, Inc.

McGRAW-HILL  
PUBLISHING COMPANY, INC.

Publication Office  
99-129 North Broadway, Albany, N. Y.  
Editorial and Executive Offices  
330 West 42nd Street, New York, N. Y.

James H. McGraw, Jr., President  
Howard Ehrlich, Executive Vice President  
James H. McGraw, Honorary Chairman  
B. R. Putnam, Treasurer  
D. C. McGraw, Secretary  
A. W. Morrison, Circulation Manager

Cable Address:  
MCGRAWHILL, New York  
Member A.B.P. Member A.B.C.

## CONTENTS—APRIL, 1938

ANTENNA SUPPORT INSULATOR — British G. P. O. installation at Rugby .....	Cover
FIREBOAT COMMUNICATIONS—By Frank Borsody.....	10
How New York's Fire Department applies radio for alarms and directions	
CATHODE-RAY TUBE APPLICATIONS—By H. F. Mayer.....	14
Tracing tube characteristics on a C-R screen	
A PRACTICAL METAL DETECTOR—By W. C. Broekhuysen....	17
Details of a tuned-bridge amplifier and detector for indicating the presence of small metallic particles	
CBS BUILDS NEW HOME FOR KNX.....	20
Architectural, acoustical, and audio facilities of the new Pacific Coast headquarters of the Columbia Broadcasting System	
MEASUREMENT OF TRANSMISSION LINE CONSTANTS.....	26
Use of a Q-meter for high frequency measurements. A contribution of the Ballantine Laboratories	
TELEVISION RECEIVERS—By E. W. Engstrom and R. S. Holmes	28
Sensitivity and gain requirements, antenna structures, etc. First of a series of articles, from RCA's Camden laboratories, on television	
HIGH DEFINITION TELEVISION PICTURES.....	32
German and American examples of the degree of perfection now obtainable	
PHOTOGRAPHING CATHODE-RAY SCREEN TRACES.....	37
For reference use, compiled by R. S. Morse of Eastman Kodak	
SOLVING A RECTIFIER PROBLEM—By Reuben Lee.....	39
Improving regulation by the use of tuned filter chokes	

## DEPARTMENTS

CROSSTALK .....	9
TUBES AT WORK.....	36
REFERENCE SHEET.....	37
ELECTRON ART .....	48
MANUFACTURING REVIEW.....	54
PATENTS .....	66
INDEX TO ADVERTISERS.....	68

**MEMO**  
for  
*Designing  
Engineers*

## **FLEXIBLE SHAFTING is ideal for jobs like this...**

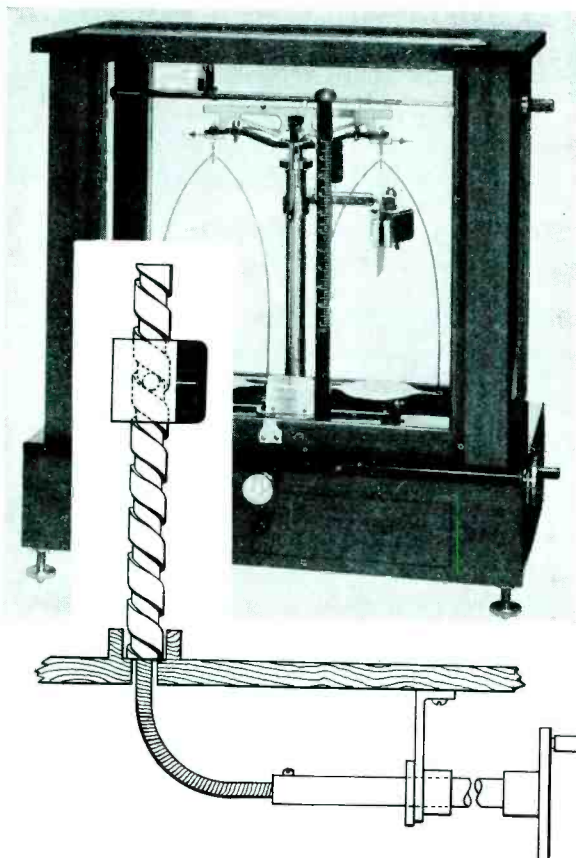

*Analytical Balance (patented) product of Seederer-Kohlbusch, Inc., Jersey City, N. J. Photo courtesy of the manufacturer.*

Note how the right angle turn in the vernier slide control of this analytical balance is made with a short piece of flexible shafting.

It is safe to say that this is the simplest and most economical way to make that turn—or, in fact, to couple parts that are in any degree out of alignment.

Even in some cases where parts could be connected with a rigid shaft, it would pay to use flexible shafting instead, because accurate alignment would then be unnecessary and assembly time and cost would be reduced.

Flexible shafting may also make possible a more effective arrangement of parts and more favorable over-all dimensions, because it permits you to place parts which require coupling, where you want them, without regard to alignment.

So, keep flexible shafting in mind when you design. Remember, it is available in a wide range of sizes and physical characteristics—in both power drive and remote control types—and in any length.

### **ENGINEERING COOPERATION**

*Always available, without obligation, for working out specific applications. Just send us essential data.*

### **KEEP YOUR KNOWLEDGE OF FLEXIBLE SHAFTS UP TO DATE**

From time to time we publish bulletins giving information and engineering data about flexible shafts, new developments and actual applications. If you would like to receive this material, write us to put your name on our mailing list.

# **S. S. WHITE**

The S. S. White Dental Mfg. Co.

## **INDUSTRIAL DIVISION**

10 East 40th St., Room 2310E, New York, N. Y.

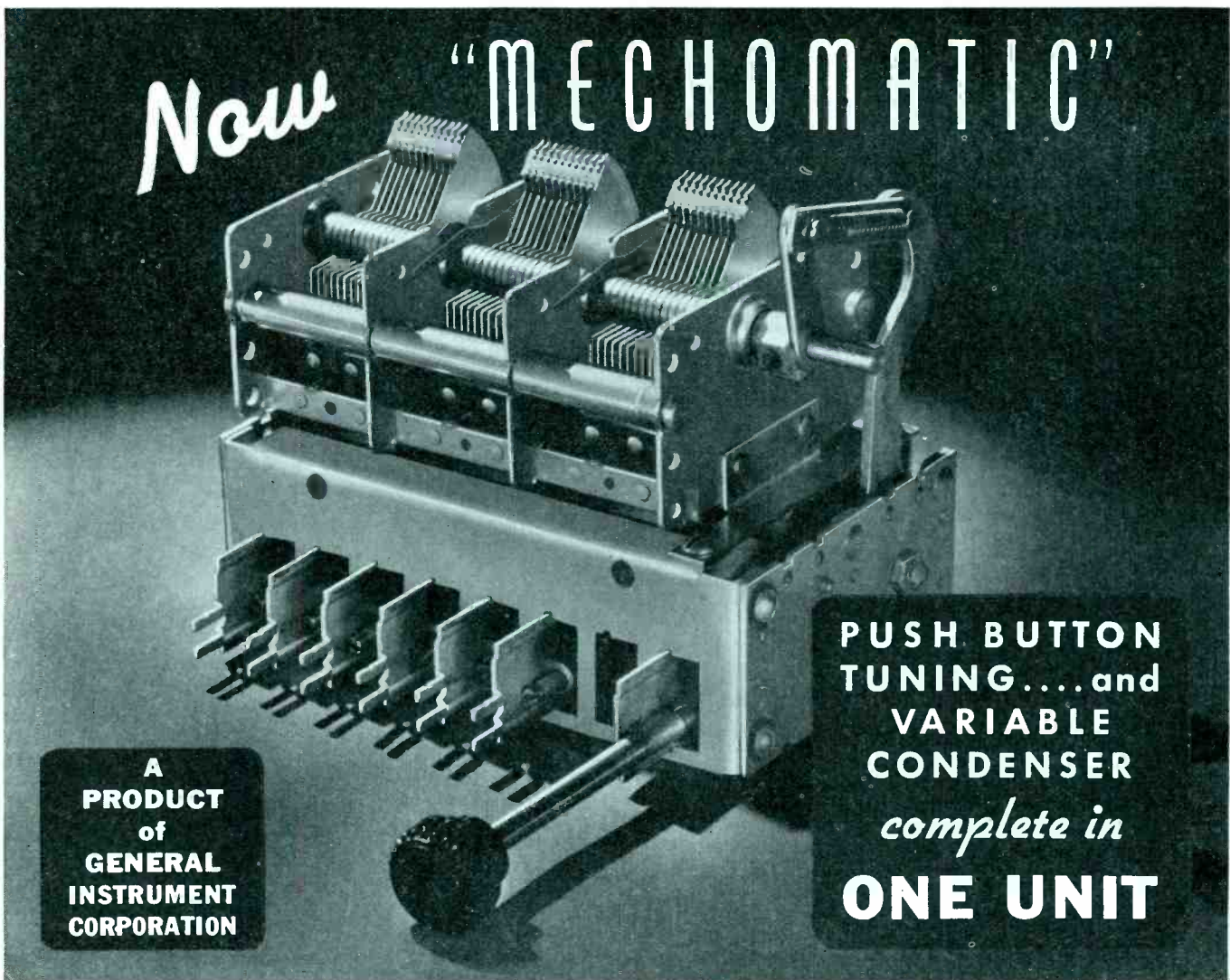

● Presented to the Export Trade by . . . **AD. AURIEMA, INC.**

*"Mechomatic"* is designed and made to be the low cost, quick solution to all factors of the push button tuning problem:

1. Instantaneous tuning.
2. Repeat accuracy within 1000 cycles.
3. Simple front adjustment by user.
4. Easily adaptable to both push button and manual control.
5. Variety of knob and dial arrangements.
6. Low cost.

Supplied in 4 to 10 button frames with General Instrument type 1700, 2000, 2300 or 2400 condenser mounted as shown above, with front or rear shaft

extension as required. (Tuning unit available only with condenser.)

Photo shows six button unit in eight button frame with manual control and three gang, type 2300, variable condenser.

Write, or cable code word "MECHO" for technical bulletins and prices of all sizes and types in production quantities.

Write, or cable code word "MATIC" for sample as illustrated, and forward \$4.50 for total charges to any port of destination. Bulletins and prices will be sent with all sample orders.

## Ad. Auriema, Inc.

EXPORT DEPARTMENT

116 BROAD ST., NEW YORK, N. Y., U. S. A.

Cable Address: AURIEMA, New York

Ad. Auriema, Argentina, S.R.I.  
Defensa 683  
Buenos Aires, Argentina.

Ad. Auriema, Brasileira, S.A.  
Rua Buenos Aires 17  
Rio de Janeiro, Brazil.

Ad. Auriema, Brasileira, S.A.  
Rua Barao Itapetininga 297  
Sao Paulo, Brazil.

American Radio Agencies  
Pasaje de Marimon 8  
Barcelona, Spain.

**Do your built-in meters point to FORESIGHT?**

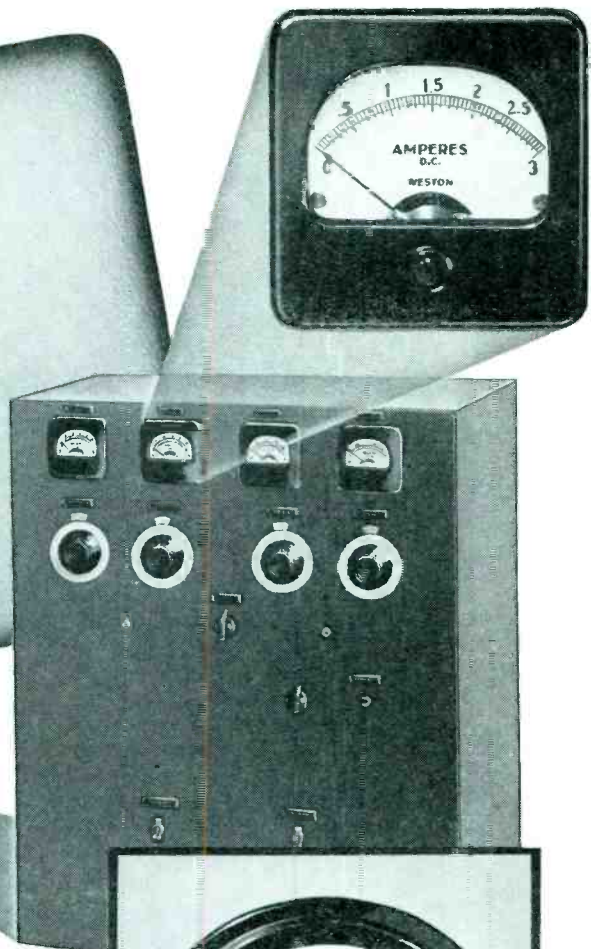

When careful buyers check your equipment against the field, do the meters on the control panel back up your emphasis on engineering *foresight*? Four times out of five, these indicating meters are the nerve-center which determines safe, dependable control of the entire machine. Can you point to WESTON on the scale plate as evidence of rigid specifications at such vital points?

Both you and your customers benefit when you build-in WESTON Instruments. Assuring a true check on operating conditions, they protect the machine itself, and the work the machine performs. Their ability to stand up under difficult conditions means better control for your equipment, and fewer calls for servicing. Machine operators get the most from units equipped with meters they're sure they can trust.

There's a WESTON Instrument for practically every "built-in" need. The WESTON representative in your locality will be glad to aid you in choosing the model that can do the most for you. Weston Electrical Instrument Corporation, 618 Frelinghuysen Avenue, Newark, New Jersey.

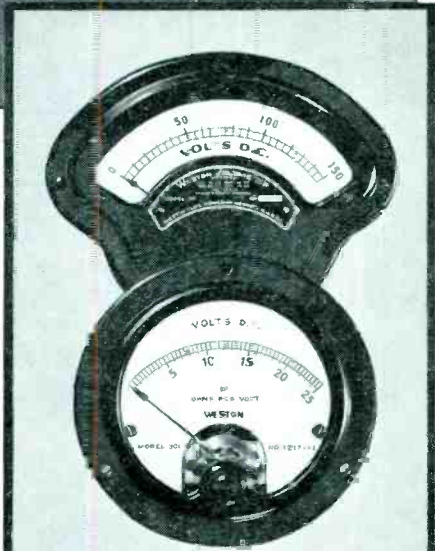

***Build-in WESTONS***

A wide range of WESTON Instruments are now being "built-in" on machine tools, rectifiers, welding machines, radio transmitters, alarm systems, therapeutic and scientific apparatus and wherever a close check or electrical quantities is vital to operation and control. There is also a WESTON Instrument available for your built-in requirements. Let us send full details.

**WESTON *Instruments***

# A NEW CRYSTAL PICK-UP CARTRIDGE and A NEW TONE ARM OF SOLID WALNUT

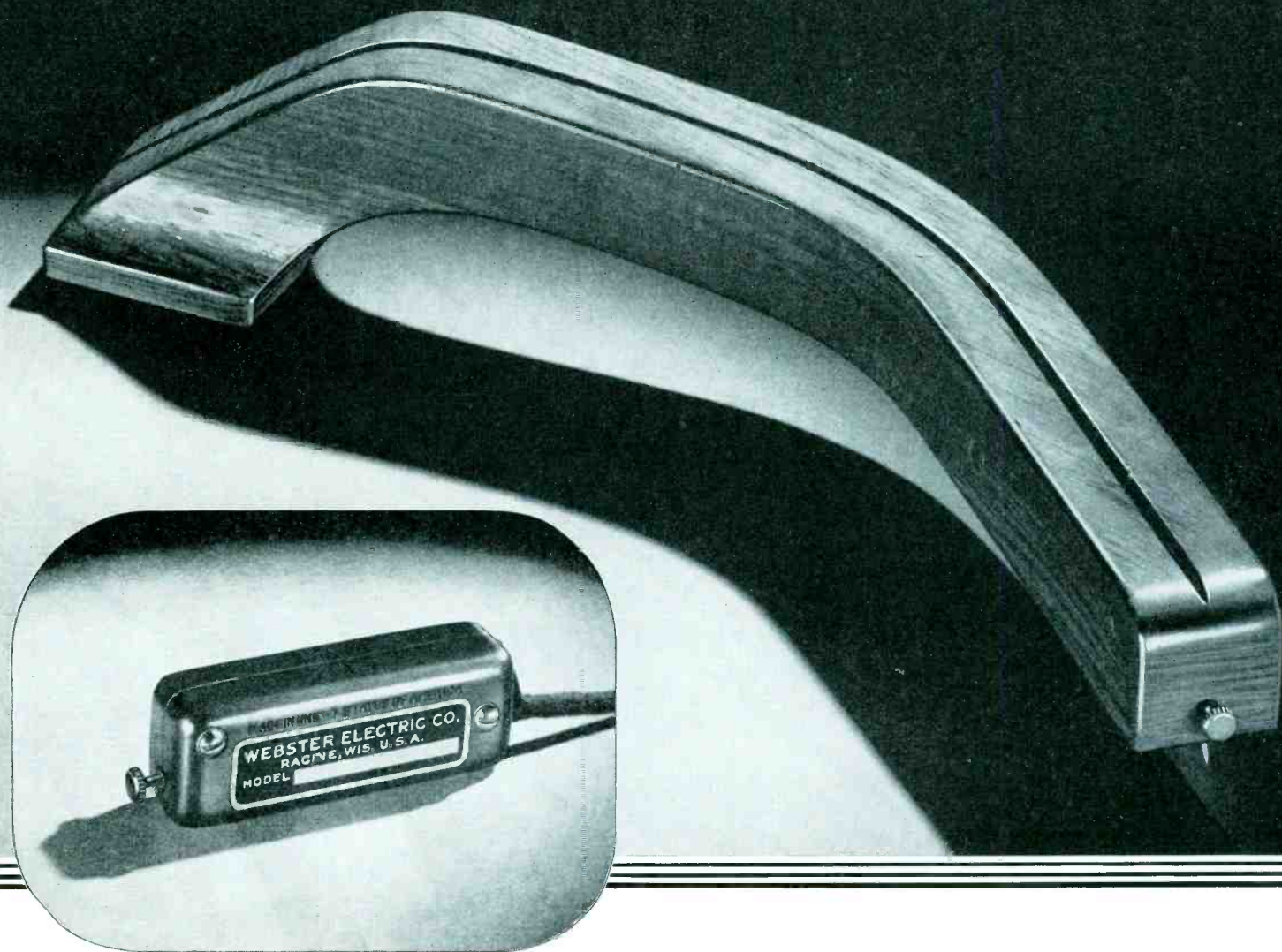

● This new Crystal Pick-Up Cartridge is replete with features. These features are: (1) It is completely moisture-proofed, being sealed in flexible moulded rubber . . . (2) It is compact—as small as consistent with good practice . . . (3) It is electrostatically and electromagnetically shielded . . . (4) It is of high capacity, low reactance; has low needle point impedance and improved tone . . . (5) It has low internal resonance. Response characteristics adequate under high temperature. Has a 200% safety factor against breakdown . . . (6) Its assembly involves no soldering—leads may be brought directly out of the cartridge . . . (7) The housing is of steel, accurately drawn and carefully ground; finished in statuary bronze plate . . . In every

detail, it is typical Webster Electric quality. (Pat. Applied For.)

The new tone arm, illustrated above, is made of wood—hand-rubbed solid walnut. The design is original and individual. It reduces tracking error from about 15° to 3°. This results in better reproduction and longer wear. Full lift hinge permits easy needle replacement. It is fitted with the new Webster Electric crystal cartridge.

The walnut tone arm illustrated above is only one of a completely new line of Webster Electric Pick-Up devices to meet a full range of requirements as to performance and price.

WEBSTER ELECTRIC COMPANY, RACINE, WISCONSIN, U. S. A.  
ESTABLISHED 1909  
Export Dept.: 100 Varick St., New York City • Cable Address "ARLAB" New York

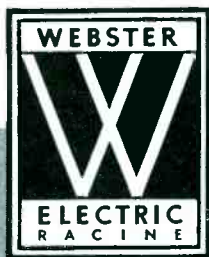

# Webster Electric

PORTABLE AND SEMI-PORTABLE SOUND SYSTEMS • ELECTRONIC INTER-COMMUNICATING SYSTEMS • ELECTRIC PHONOGRAPH PICK-UPS • TRANSFORMERS AND FUEL UNITS FOR OIL BURNERS

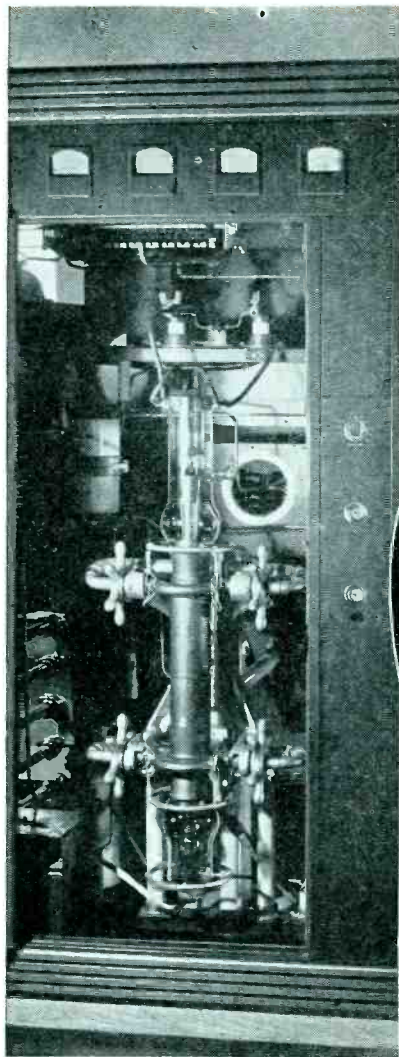

One of two 100 KW tubes in final amplifier stage of Western Electric's new 50 KW transmitter. Note accessibility.

# NEW 100 KW TUBE

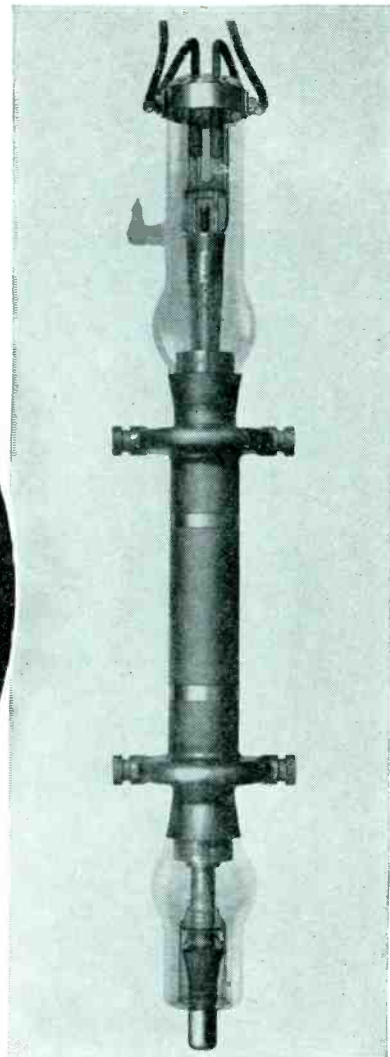

## The Western Electric 298A

*... with these outstanding features*

*Extra large filament* assures long life and low tube hour cost.

*Double ended construction:* water jacket is a permanent part of anode structure—permits quick change of tubes without using tools. Also permits operation at higher frequencies than are possible with other tubes of comparable ratings.

*In the Doherty Circuit,* two 298A's make an ideal final amplifier stage for 50 KW transmitters.

*Copper-to-glass seals* used for all lead-ins permit safe operation without cooling air streams.

*Copper lead-in and terminal* for grid allows safe conduction of charging currents and heat.

*Filament tension spring* located in relatively cool portion of tube.

*Hand wheels* of tube mounting facilitate quick changes.

*Designed by Bell Telephone Laboratories.*

### Rating Information

Nominal Filament Voltage.....	27 volts
Average Filament Current.....	225 amperes
Average Filament Emission.....	35 amperes
Amplification Factor.....	32
Average Plate Resistance at	
18,000 v. and -250 v. bias.....	1450 ohms
Transconductance.....	22,000 micromhos
Normal Water Cooling Flow.....	40 gals. per min.
Maximum Plate Dissipation.....	100 kw.
Maximum Plate Voltage.....	20 kv.
Maximum Plate Current.....	11 amperes
Approx. Inter Electrode Capacities	
Plate to Grid.....	48 mmf.
Plate to Filament.....	10 mmf.
Grid to Filament.....	31 mmf.

### Distributors:

Graybar Electric Co., Graybar Building, New York. In Canada and Newfoundland: Northern Electric Co., Ltd. In other countries: International Standard Electric Corp.

# Western Electric

RADIO TELEPHONE BROADCASTING EQUIPMENT







*Parts made of Nickel are proof against rust... They resist corrosion and all attacks of moisture...*

Moist hands, tiny beads of perspiration—yet delicate metal parts must be handled by the million. And in modern radio tube production *rust* means *rejection*. So Nickel is desirable because, among other reasons, it *cannot* rust: Nickel wire, strip and tubing are solid, non-rusting metal—*permanently* rust proof.

Nickel also resists the corrosive action of chlorinated solvents used

*Corrosion by Moist Carbon Tetrachloride at Room Temperature*

METAL	Loss in Weight Mg/Sq. Dm./24 Hrs.	REMARKS
Low C Steel	6.640	Marked corrosion and slight pitting, metal covered with heavy deposit of $Fe_2O_3$ plus $Fe_3O_4$ .
Nickel	0.028	No corrosion, very faint blue or yellow spots on surface of bright metal.

in cleaning parts (see data in above table). So troublesome corrosion products are not carried into the tube to undermine its quality.

Because frequent handling and corrosive cleaning fluids fail to affect Nickel, delicate parts are safe in storage; safe in assembly; safe in the tube. Hence, Nickel makes better radio tubes, cuts down rejections, increases yield — and reduces

the cost of *finished tubes*.

What Nickel's unique combination of properties does in radio tubes, it does in many other electrical applications. Write us about your metal problems. Ask also for "Nickel in the Radio Industry." Address: "Electrical Research," c/o

# NICKEL

**THE INTERNATIONAL NICKEL COMPANY, INC., 67 WALL ST., NEW YORK, N. Y.**



# Presents a New Multiple Circuit Push Button Switch of Extreme Flexibility

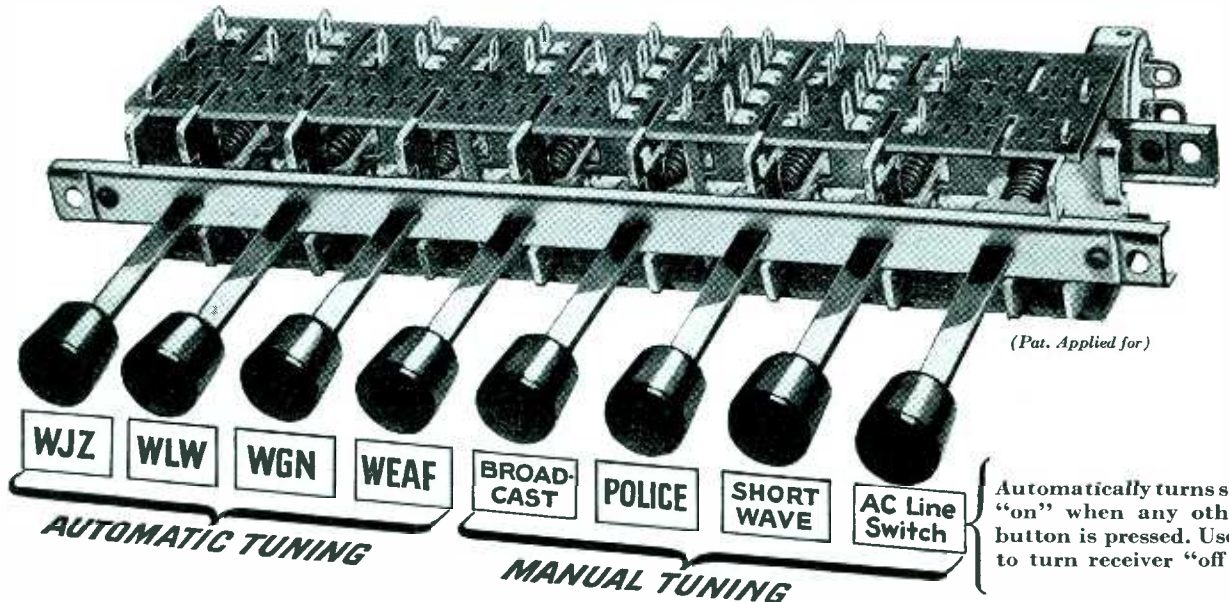

The type MC push button switch represents months of study of circuit requirements of both motor-actuated and tuned-circuit substitution methods of automatic operation.

It employs a wiping contact like the Yaxley RL wave change switch, and offers circuit combinations not previously available in a latching push button switch.

The basic design consists of two spaced terminal boards on either side of plungers carrying double rows of terminals. These terminals contact movable shoes on sliding bakelite members, which are driven by the plunger. Terminal boards have four rows of terminals on either side of the sliding member. Eight terminals to each plunger on both sides of the switch make a total of sixteen terminals for each plunger. Switching combinations may use any or all terminals, or any terminals may be omitted.

*The advantages of the Type MC Switch are:*

1. Protected terminals: active switching parts are protected from soldering and handling. Flux cannot reach contacting surfaces.
2. More terminal combinations per plunger are possible and present a variety of possible interconnections for transfer and wave band switching.
3. Two plunger center spacings— $\frac{3}{4}$  inch and  $\frac{5}{8}$  inch are available.
4. Capacity between terminals and terminals to frame minimized by careful design.
5. Side action latch bar allows mechanical interconnection of two switches.
6. Silent action.
7. All strain of mechanism when mounted relieved by embossed mounting pads. Mounting holes in line with plungers. Holes may be provided for trimmer condensers or iron core tuning units.

8. Flat plunger and spring provide shielding directly between terminals on opposite sides of the board.
9. Depth of switch behind mounting surface reduced to  $1\frac{5}{8}$  inches over the end of the actuated plunger when three rows of terminals are used.
10. Provision can be made to actuate an AC line switch on either end plunger.
11. The sliding contact shoes may be specified to accomplish either shorting or non-shorting switching sequence.
12. One terminal board and its sliders may be eliminated on simple switching applications.

*Write for specification sheet (shown below) and additional information.*

**YAXLEY MANUFACTURING DIVISION**  
of **P. R. MALLORY & CO., Inc.**  
**INDIANAPOLIS INDIANA**  
Cable Address—PELMALLO

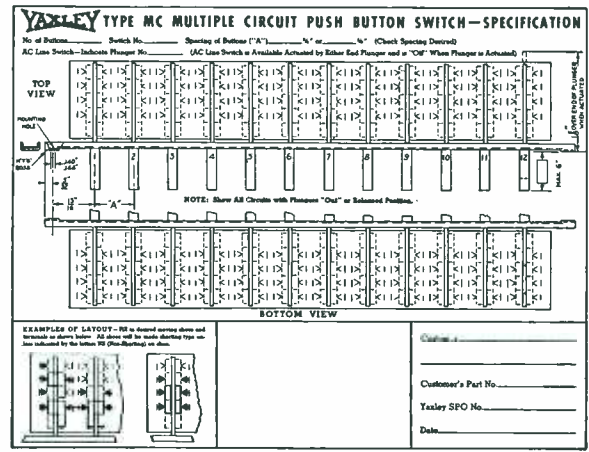

# ELECTRONICS

APRIL  
1938



KEITH HENNEY  
Editor

## Crosstalk

### ► TRANSLATIONS PLEASE . . .

From time to time *Electronics* has been honored with technical manuscripts from Germany, Russia and other countries in which languages other than English are spoken. Some of these articles have found their way into the editorial pages. The responsibility of having these manuscripts translated has fallen upon the editors who have farmed out this task to engineers more conversant with the languages concerned. This responsibility, however, is a real one since shades of meaning are often not correctly handled with the result that the author is not satisfied.

It has been decided, therefore, that manuscripts for editorial consideration should be presented in English thus shifting to the author the translation difficulty. Authors will be paid at rates which apply to any contributor; whereas authors in the past have only received the difference between these regular rates and the cost of translation.

► **WEAF, WJZ . . .** All of NBC's 50 kw stations are undergoing technical changes. WEAF and WJZ are already on the air with the new arrangement which involved widening the transmission band so that it covers without loss the region between 30 and 17,000 cps; the use of reversed feedback to decrease distortion by a factor of 30 db; and extensive changes to reduce audio phase shift so that the wide frequency band could be utilized.

New studios and a new anti-fading antenna are going into WTAM plus the same improvements made at WJZ and WEAF; WRC sports a new high fidelity transmitter and a new anti-fading antenna.

► **TRENDS . . .** Much of the economic plight of the railroads is blamed on trucks, airplanes, automobiles. Call this technological advance, or something. Government competition is worrying the public utilities greatly. But diesel motor power plants of small size for use by the private individual are

coming into great popularity. Perhaps this is technological advancement.

Increasing numbers of stations in the limited broadcast spectrum require receiver manufacturers to increase selectivity at the cost of tone fidelity. Stereotyped programs, poor receiver tone quality, advertising blurbs that are too long or too blatant may have something to do with the steadily increasing sales of phonographs and records. In March was described a new pickup which has a very wide frequency range, and which conserves record life. Furthermore, frequency modulation as a system for providing high fidelity noise-free entertainment is to undergo its first large-scale test when summer static begins this year.

Broadcasting, complacent technically, has less to fear from Government than from complacance. Radio listeners may find other, and perhaps better, means of getting their music. And engineers may find other and better means of transmitting uncanned music leaving the old timers in the present position of the railroads—lots of track but no travelers.

► **ANNIVERSARY . . .** Fifty-one years ago last month one of the most remarkable feats in the history of communication took place. A seven-year-old child, cut off from the world by darkness and silence, found suddenly that there was language and that she could communicate intelligibly with other people. This was Helen Keller, and her teacher was Anne Sullivan (Macy). For the deaf and blind, words are mere thumps and movements of another person's hands, spelling by means of the manual alphabet.

The story has often been told. Day after day Miss Sullivan spelled words into Miss Keller's hands. But there was no answering click. Then one day she pumped water onto Miss Keller's hands and at the same time spelled "water." Then the spark passed. Within a few hours the child, eager for knowledge learned dozens of words and

within a few weeks acquired a good working vocabulary.

None of us who get joy out of making things work with the aid of our beautifully fashioned engineering and scientific tools can approach the ecstatic feeling accomplishment that must have flashed through Miss Sullivan's mind as she realized her accomplishment.

► **LOCAL RECEIVER . . .** For years editors and other people who don't know much about the business of manufacturing and selling radio receivers have begged manufacturers to make a local receiver, one with low sensitivity but good selectivity and wide audio range, a sort of set which one could use to hear local programs with a maximum of tonal enjoyment. Manufacturers state that they cannot sell such sets.

Now, however, RCA Victor offers for sale just such a receiver. It is called the Symphony model, it sells at \$125, covers the broadcast band only, and has an audio range of from 50 to 7000 cycles. It tunes exclusively by push button.

For reasons aside from the purely personal pleasure of proving our point, we hope Victor sells a million of these sets and with it pushes the audio-skipping jobs off the market.

► **SLICK . . .** Nifty little items have recently appeared on the market in the form of tape recorders that can be connected to the output of an all-wave receiver (or any other set that gets code). These are inexpensive, employ chemically treated tape, and when connected to the set make it into a code reader. Of course the general run of code stuff that floats through the short waves make poor reading because it is in certain commercial code forms as well as in Continental Morse. But Arlington still sends good English, and certain news broadcasts in code anticipate the newspapers by a half day or so.

Map of New York Harbor and environs showing locations of fireboats and land station equipment of the fireboat radio communication system of the City of New York.

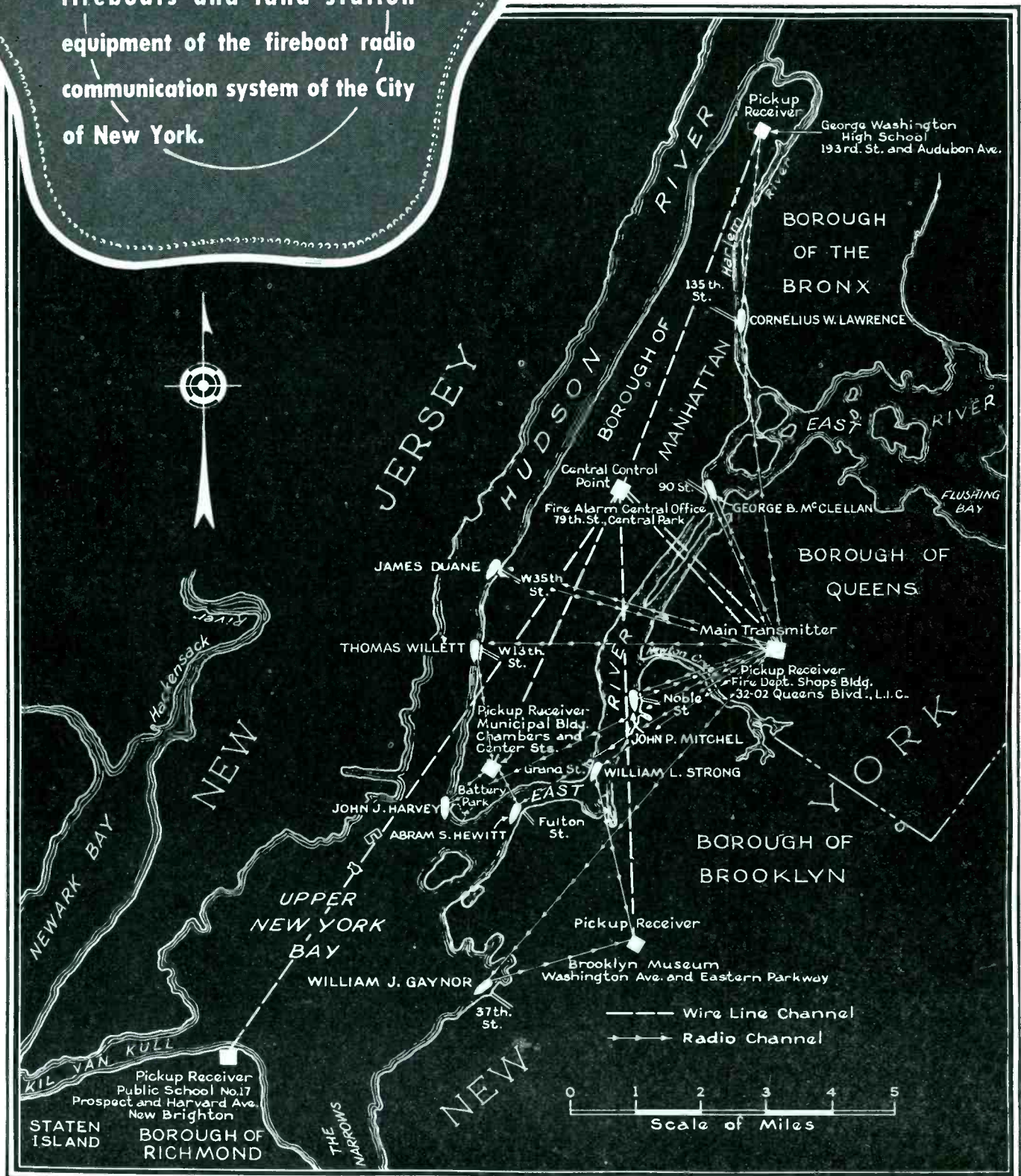

# New York City's Fire Boat Communication System

**N**INE large "floating engines" or fire boats, in addition to hundreds of pieces of land fire-fighting apparatus, are operated by the Fire Department of the City of New York. Upon the nine fire boats falls the responsibility for protecting the 651 miles of waterfront, and the immense amount of shipping within the boundaries of the Port of New York, one of the world's largest seaports. It was early realized that radio communication applied to the fire boat fleet would give the marine fire extinguishment service additional speed and flexibility.

Since the initial fire boat radio tests in 1913, the New York Fire Department has conducted extensive tests of various systems of radio communication. It was found that many local factors existed that were detrimental to effective radio-tele-

phone coverage. The dense masses of skyscrapers, and numerous large bridges absorbed the energy contained in radio waves. In many parts of the city, hills rise to three and four hundred feet above the surrounding waterways. The radio noise level, an accompaniment of urban and industrial activity, was found very high.

In recent years, when ultra-high frequency radio apparatus became commercially available, the Fire Department turned to this portion of the spectrum for a possible solution of its communication problem. Many field tests were made, using ultra-high frequency communication with fire boats. However, these field

tests, like previous tests with longer waves, proved unsatisfactory.

Early in 1936 a final and intensive study was made of the data obtained by the Fire Department in its many tests with medium-high and ultra-high frequency apparatus. The engineers of the Fire Department concluded that ultra-high frequency channels were unsuitable for use by the Headquarters transmitting station. One reason for this conclusion was that because of the propagation characteristics at least three Headquarters ultra-high frequency transmitters would be needed to avoid dead spots. To avoid interference with one another, the three transmitters would have to be operated selectively as to area, or on different frequencies, or synchronized. The latter method at that time would have been a major developmental problem. Three transmitters would not only be expensive, but would introduce complexities of apparatus and operation. A further disadvantage was the fact that the mobile receiving aerials would be down among interference and effects particularly inimical to ultra-high frequency radio reception.

The channel specified for the Headquarters transmitter was 1630 kc, assigned by the Federal Communications Commission to the marine fire emergency service. Transmissions at this frequency exhibit to a considerable degree broadcast wavelength characteristics. A service area of reliable reception surrounds the transmitting antenna, depending mainly upon the ground wave, which can be predicted with a fair degree of accuracy.

For the fire boat transmitters, it was decided that the same frequency used by the Headquarters station, or another medium-high frequency, would be unsuitable. The mobile antenna would be too short to radiate efficiently, and it would be impossible to mount the antenna the desirable half-wave or more above the sur-

By **FRANK BORSODY**  
*Radio Supervisor  
Fire Department, City of New York*

Fireboat *John J. Harvey* off the Battery in New York Harbor



rounding water at such comparatively long wavelengths.

The high frequencies, from 3,000 to 30,000 kc, were considered useless for the fire boats, because of strong short- and medium-distance skip effects, changing radically during each day with the movement of the sun and seasonally.

The channels between 30,000 and 42,000 kc seemed especially suitable for the use of the fire boat transmitters. At such very high frequencies it would be possible to place the antenna so as to polarize vertically the transmitted wave, the most favorable condition with respect to propagation from a low elevation, particularly over salt water. The use of ultra-high frequencies by the fire boats would also make possible two-way radio communication with land fire-fighting units with a minimum of additional apparatus. A study of the results of previous ultra-high frequency field tests, and other data, indicated that about five properly located remote pickup receivers would be sufficient.

When the foregoing general conclusions had been arrived at, a final field test was arranged, with two purposes in mind. The first, to test the suitability of the proposed location of the Headquarters transmitter, and the second, to select the sites of the remote receivers. The site tentatively picked for the location of the Headquarters transmitter was the Fire Department Repair Shops Building, an L-shaped reinforced concrete structure 110 feet high, at Queens Boulevard and Van

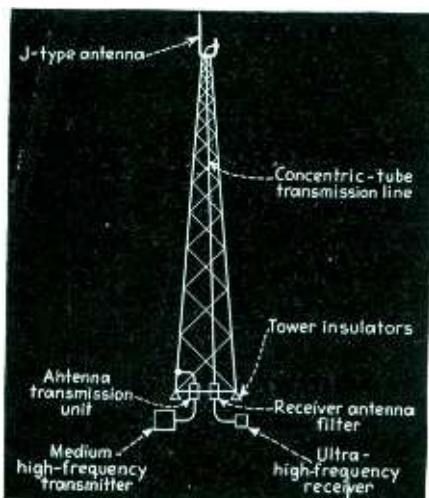

Combination antenna for medium and ultra high frequencies

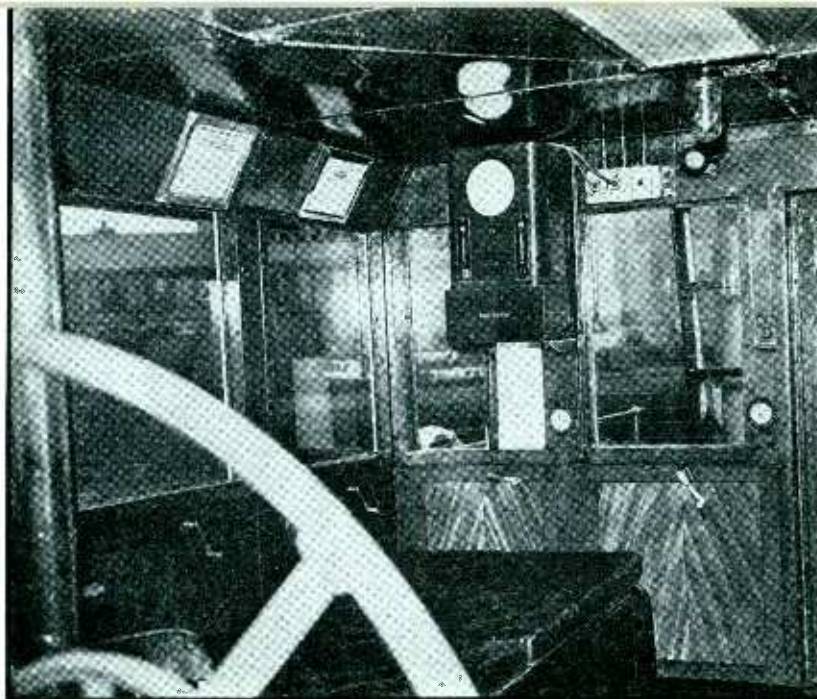

Pilot house on the *Harvey* showing placement of the medium high frequency receiver on the wall

Dam Street, Long Island City, Queens. Preliminary examination of the site showed that this building commanded a view of the Harlem River valley, an area revealed in every previous field test as unusually difficult to "work" with radio signals. This proposed transmitter site, also, was near those sections of the city with the heaviest traffic and densest groups of tall buildings and bridges, where receiving conditions were most unfavorable. It was desired to locate the transmitter near such difficult areas, in order to place the strongest possible signal in them. In addition, the proposed site was open and elevated enough to reach efficiently the remote and less built up sections. Therefore, during the final field test, a portable transmitter was operated on 1616 kc at the Repair Shops Building, and observed aboard the fire boat making the test trips. This portable transmitter (WIEW) was loaned to the Fire Department by NBC.

On June 4th, 1936, the Fire Boat James Duane sailed around Manhattan Island, and made side trips into Long Island Sound, Newtown Creek, the New York Navy Yard, and the Gowanus Canal. On the following day, the Fire Boat James Duane sailed around Staten Island, and made side trips into Gravesend Bay and Coney Island Creek. Throughout the fire boat's travels, the medium-high frequency transmissions from the temporary land transmitter in Long Island City were continuously logged as to readability. At the same time, at eight listening points

in the city, the Fire Department recorded audio and meter observations of the 31,600 kc test transmissions from the Fire Boat James Duane. The 25-watt transmitter (W1OXT) used on the Fire Boat James Duane was loaned to the Fire Department by RCA.

As one result of these final tests, the sites of the five pickup receivers were decided upon. These locations had been selected for testing because they were on natural and man-made elevations, and in public buildings. A high position for the receiving aerial was considered essential because all data indicated that the most important single consideration for efficient ultra-high frequency reception was the locating of the receiving aerial as high as possible above the average roof level of surrounding buildings. Public buildings were selected because the Fire Department would not be required to pay rental charges, would have control of the premises, and would be assured of fairly permanent tenure of occupancy.

After the final medium-high and ultra-high frequency field test, a two-way radio-telephone communication system which would cover the entire Port of New York could be visualized. It would consist of a medium-high frequency Headquarters station in Queens, ultra-high frequency transmitters on the fire boats, and five remote receivers strategically located about the City. Accordingly the specifications for the manufacture and installation of the equipment were written.



Central control room of fireboat system. Telephone monitor board, receiver, frequency monitor and power supply unit

The New York Fire Department fire boat radio-telephone communication system was furnished and installed by the General Electric Company, the successful bidder. A list of the apparatus included in the system follows:

- (1) A 500-watt Headquarters transmitter with vertical antenna, operating on 1630 kc, located on the roof of the Repair Shops Building in Queens.
- (2) Five remote receivers (35,600 kc), with aerials and land-line coupling equipment, located at:
  - (a) George Washington High School, northern Manhattan.
  - (b) Municipal Building, southern Manhattan.
  - (c) Public School 17, Staten Island.
  - (d) Brooklyn Museum, Brooklyn.
  - (e) Fire Dep't Repair Shops Building, Queens.
- (3) A 50-watt crystal controlled transmitter (35,600 kc), a 1630 kc receiver, with turbo-motor-generator power source, on each of the nine fire boats:
  - (a) "John J. Harvey," Battery Park, Manhattan.
  - (b) "George B. McClellan," East River, Manhattan.
  - (c) "James Duane," Hudson River, Manhattan.
  - (d) "Thomas Willett," Hudson River, Manhattan.
  - (e) "Cornelius W. Lawrence," Harlem River, Manhattan.
  - (f) "William J. Gaynor," Upper N. Y. Bay, Brooklyn.
  - (g) "John Purroy Mitchel," East River, Brooklyn.
  - (h) "Abram S. Hewitt," East River, Brooklyn.
  - (i) "William L. Strong," East River, Manhattan.
- (4) The Central Control Station or Headquarters, located in the Manhattan Fire Alarm Central Office, in Central Park, Manhattan. WYNF, the Headquarters transmitter 3 miles distant in Queens, is remotely controlled from this office. In the control room there are also coupling, mixing, and amplifying devices for combining and utilizing the signals from the remote pickup receivers, as received over their connecting telephone lines. Here, also, are a radio receiver, crystal frequency monitor, and cathode ray oscillograph for monitoring the Headquarters carrier.

#### How the System Operates

The fire boat radio system, in general, functions as follows. The signals sent from any fire boat transmitter are picked up by some or all of the five remote receivers, and are then automatically conveyed over the connecting land-lines to the control room in Manhattan.

The Dispatcher's voice, or other signals sent from the radio control room are conducted over the connecting land-line to the transmitter in Queens, and there radiated on 1630 kc to the fire boats. To provide intercommunication among the fire boats, the signals received from any fire boat transmitter are re-radiated on 1630 kc to all fire boats, when, at the Manhattan control room the output of the pickup receiving system is connected to the land-line input of the Headquarters transmitter.

From any telephone instrument of the Fire Department two-way communication is possible with the fire

boats, by means of the combined operation of the remote pickup receiver system and the Headquarters transmitter. Although different components of the radio system are located in four of the five boroughs of the greater City, all operating and controlling functions are concentrated in the central office in Manhattan.

At the operating position an inductor microphone is used, and a line amplifier equipped with audio automatic volume control. Volume compression action makes overmodulation of the Headquarters transmitter almost impossible, and raises the average signal level in the field approximately 3 decibels, making the 500-watt Headquarters transmitter equal in effectiveness to a 1000-watt transmitter not similarly equipped. In the control room, a calibrated crystal controlled frequency meter indicates Headquarters transmitter carrier deviation. A crystal controlled monitoring receiver affords an aural check, and a 5-inch cathode ray oscillograph permits continuous visual inspection of the carrier for percentage of modulation, hum, noise, and distortion.

The same pair of wires that is used to convey the operator's voice to the Headquarters transmitter, is utilized for the application and removal of filament and plate power, and for re-setting the over- and under-load circuit breakers. The land-lines conveying the incoming signals from the remote receivers are connected to the audio mixing unit in the control room. This unit provides for the combining of the signals from ten remote receivers, five of which are for future use. Each receiver land-line terminal position is equipped with an individual line amplifier, volume indicator, and non-distorting variable attenuation equalizing pad. Switches turn the power on and off at the distant receivers, by means of relays actuated by direct current sent back over the telephone line.

Signals from any or all of the remote receivers may be connected to or disconnected from the output of the audio mixing unit without changing the output impedance, by means of switches fitted with compensating resistors. The output of the audio mixing unit may be switched to the earpiece of the operator's handset,

(Continued on page 62)

# CATHODE RAY OSCILLOGRAPH

By H. F. MAYER

General Engineering Laboratory  
General Electric Co.  
Schenectady, N. Y.

**T**O AN increasingly greater extent the communication engineer is studying the characteristic curves and performance records of his apparatus on the screen of a cathode ray oscillograph rather than a sheet of graph paper. Instead of recording columns of data and plotting a new series of points each time a parameter is varied, he snaps a switch and the curve appears. He may even vary the parameters while viewing the curve, and thereby locate an optimum point quickly and accurately—as in the now familiar system of aligning radio receiver intermediate frequency stages by means of a frequency-modulated signal and an oscillograph.

This paper deals with a single one of the many possible applications of the oscillograph; namely, the tracing of vacuum tube characteristics. The circuits described here are all completely electronic and require no rotating switches or other moving parts. While this limits the performance in certain respects, it extends the opportunity of using the system to those who may be without the facilities for building a mechanical commutator.

The most elementary circuit, designed to trace the plate current vs. plate voltage curve of a diode rectifier, is shown in Fig. 1. As the curve desired has plate voltage for its abscissa and plate current for its ordinate, one of the horizontal deflection plates of the oscillograph is connected to the cathode of the rectifier and the other to the anode; the vertical deflection plates are connected across a resistor,  $R_1$ , in series with the rectifier, to receive a voltage proportional to the plate current. Then an alternating voltage of any wave form and frequency may be applied to the rectifier and  $R_1$  in series and the oscillograph spot will move always along the curve of plate current vs. plate voltage.

Fig. 2 shows a more useful refinement of this circuit. In order to

make the curve extend to the values of current attained on peaks in actual operation it is necessary to use a voltage which is positive for only a

small part of a cycle so as to avoid excessive average current and consequent overheating of the tube. This is accomplished by inserting a load

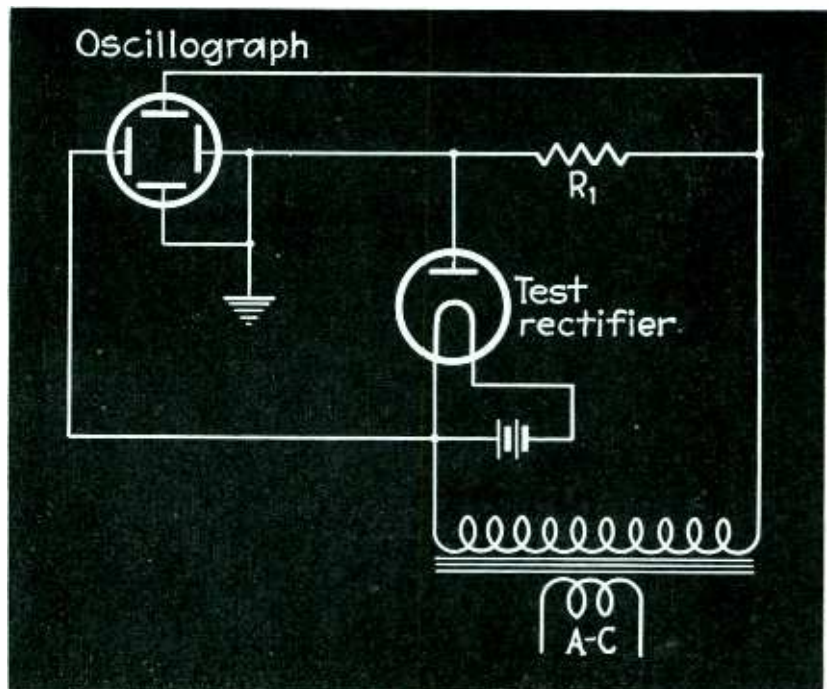

Fig. 1—Elementary cathode ray tube circuit for tracing the voltage-current characteristics of a diode

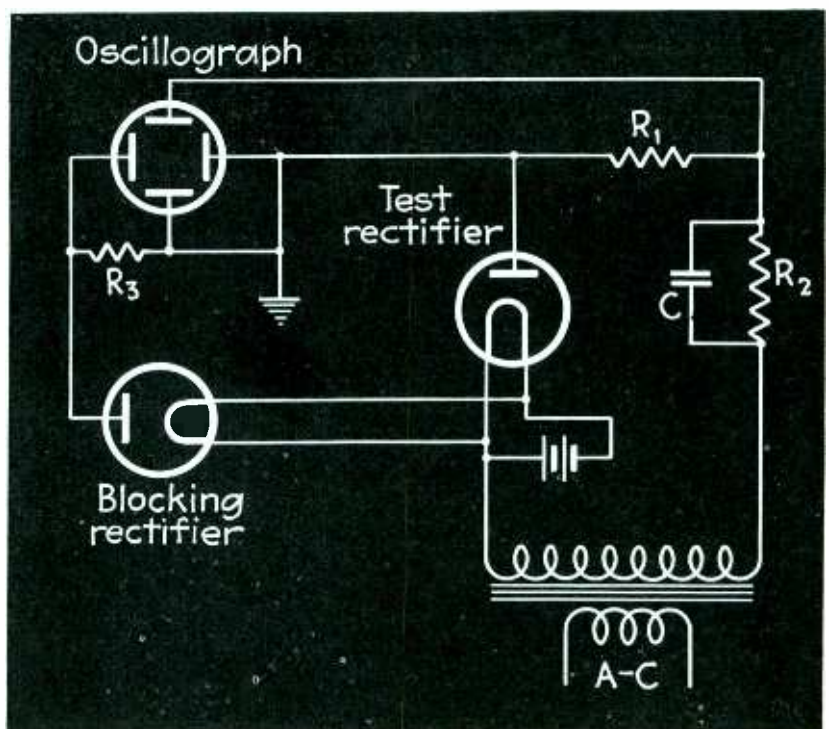

Fig. 2—Refinement of the diagram of Fig. 1 which enables peak values of current and voltage to be recorded



# APPLICATIONS

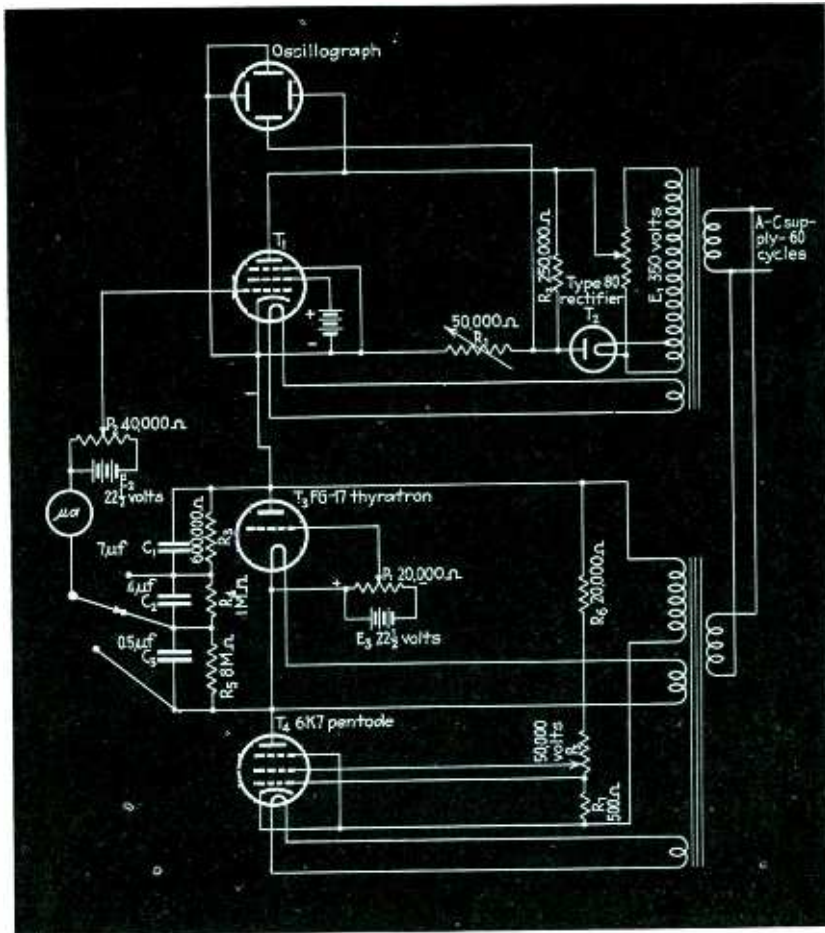

Fig. 3—Schematic wiring diagram of cathode ray oscillograph suitable for tracing the characteristics of multi-element amplifier tubes

ation is a measure of the emitting quality of the cathode. The presence of gas is immediately apparent from the shape of the curve, as is low emission. Cathode sputtering is evidenced by a flash of current at lower-than-normal plate voltage, and an arc-back shows as a surge of current in the negative direction.

To trace the characteristic curves of an amplifier tube requires a more complicated circuit. The one shown in Fig. 3 has given good results. This circuit provides a family of curves of plate current vs. plate voltage for various equally spaced grid voltages. The principle of obtaining the proper coordinates is the same as in the case of the diode, the extra apparatus here being for the purpose of providing the various grid voltages. An alternating voltage,  $E_1$ , is applied to the tube under test and the series resistor,  $R_1$ , through the rectifier,  $T_2$ , which, with the high resistance,  $R_2$ , serves to block the negative half-cycle of voltage. Thus on each positive half-cycle the oscillograph spot traces the plate-current plate-voltage characteristic of  $T_1$ , for the grid bias at that time, and during each negative half-cycle remains stationary at the origin.

resistor  $R_2$  shunted by a condenser,  $C$ , and applying a higher a-c voltage. The blocking rectifier is inserted to keep the inverse voltage from reaching the oscillograph plate, and the high resistance,  $R_3$ , to permit the charge to leave the plate after reaching it through the blocking rectifier. This circuit became an almost indispensable part of a test set during the development of a small high-vacuum rectifier. In testing the tubes, the load,  $R_4$ , and the voltage are adjusted to operate the tube at full output and rated inverse peak voltage. Then with the tube cold, the high voltage and the filament voltage are applied simultaneously, and the building up of emission as the filament heats is observed on the oscillograph. The time required for the curve to reach the lower limit set for satisfactory oper-

Fig. 4—Cathode ray oscillograph circuit for tracing the trans-conductance as a function of the control grid voltage

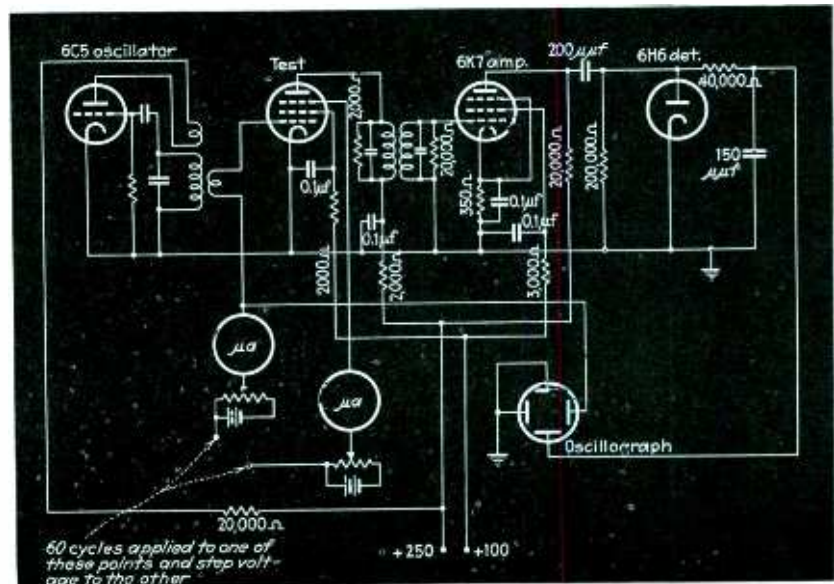

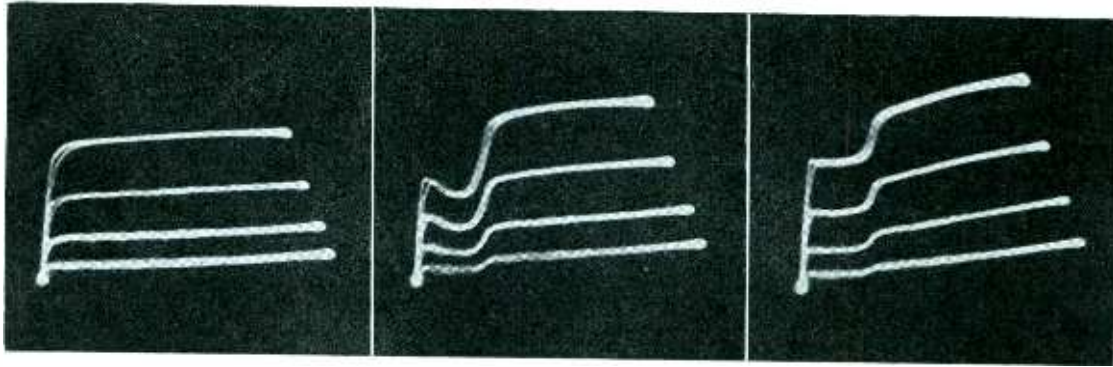

Figs. 5A, 5B, and 5C, from left to right, showing the characteristics of a 6J7 tube. The conditions under which measurements were made are given in the text

To trace a complete family of curves for various grid voltages, the grid voltage must be held constant during positive half-cycles, while the spot is moving, and changed by a fixed increment during negative half-cycles. This is accomplished by charging the condenser chain,  $C_1$ ,  $C_2$ ,  $C_3$ , through the pentode,  $T_1$ , in steps, and finally discharging it through the thyatron,  $T_2$ .  $C_1$ ,  $C_2$ ,  $C_3$  is charged in steps due to the fact that the pentode,  $T_1$ , has an alternating voltage on its screen and control grids, and hence conducts only during alternate half-cycles. The voltage,  $E_6$ , is phased with respect to  $E_1$ , so as to make  $T_1$  conduct during negative half-cycles of  $E_1$ . Since the current passed by  $T_1$  is substantially independent of its plate voltage, so long as it exceeds the screen voltage, the increments of charge applied to  $C_1$ ,  $C_2$ ,  $C_3$  are equal. The amount of the increment depends upon the setting of the screen potentiometer,  $P_3$ . When the voltage on  $C_1$ ,  $C_2$ ,  $C_3$  reaches a value determined by the setting of  $P_1$ , the thyatron fires and discharges  $C_1$ ,  $C_2$ ,  $C_3$ .

The other details of the circuit are of minor importance, but contribute to the stability and flexibility. The reason for using three condensers  $C_1$ ,  $C_2$ ,  $C_3$  instead of a single one is to provide three ranges of maximum bias voltage. The resistors,  $R_1$ ,  $R_2$ , and  $R_3$  permit a reasonable grid leakage current to flow in the tube under test. The potentiometer,  $P_2$ , across the battery,  $E_2$ , permits adjustment of the minimum bias to zero, which it would otherwise not be, since the thyatron may discharge the condensers to almost any voltage, depending upon the circuit constants. The microammeter in the grid circuit

of the tube under test facilitates the adjustment of  $P_2$ .

The oscillograms of Fig. 5 show the results of a few minutes' work with the camera. The curve of Fig. 5A represents the characteristics of a 6J7 with current as ordinates and plate voltage as abscissa. The control grid voltage is the parameter. The screen grid voltage is 90 volts and the suppressor grid voltage is 0. Fig. 5B represents the same conditions except that the suppressor is connected to the screen. In Fig. 5C, the suppressor is connected to the plate, but other conditions are the same as in the other two diagrams.

Another tube characteristic which may be traced in a fairly straightforward manner is the mutual conductance vs. grid voltage. The circuit of Fig. 4 accomplishes this by using the tube as a high-frequency amplifier with a low impedance load in the plate circuit and a small grid signal, and plotting the rectified output against the variable grid voltage. The signal is supplied by a 175 kc. oscillator to the grid whose mutual conductance is under consideration. If we wish to plot No. 1 grid

mutual conductance against No. 1 grid voltage for various No. 3 grid voltages, then the signal and a 60-cycle voltage are applied in series to grid No. 1, and the step-voltage, generated by the circuit of Fig. 4, is applied to the No. 3 grid. The output of the detector feeds the vertical deflection plates of the oscillograph, and the horizontal deflection plates are supplied by the same 60-cycle voltage as the grid of the tube under test. It is desirable to include a microammeter in the lead of each grid having one of the variable potentials in order to adjust the minimum bias to zero. The order of magnitude of the deflecting voltages obtained from this circuit is such as to require an oscillograph having an amplifier in each of the deflecting plate circuits.

Some curves taken with this circuit are shown in Fig. 6. Fig. 6A shows the transconductance of a 6K7 as ordinate with control grid voltage as abscissa and No. 3 grid voltage as the parameter. Fig. 6B shows the transconductance of the 6L7 as ordinate, No. 3 grid voltage as abscissa and control grid voltage as parameter.

Figs. 6A and 6B, left to right. These curves show the transconductance of 6K7 with control grid voltage and with No. 3 grid voltage as abscissae, respectively

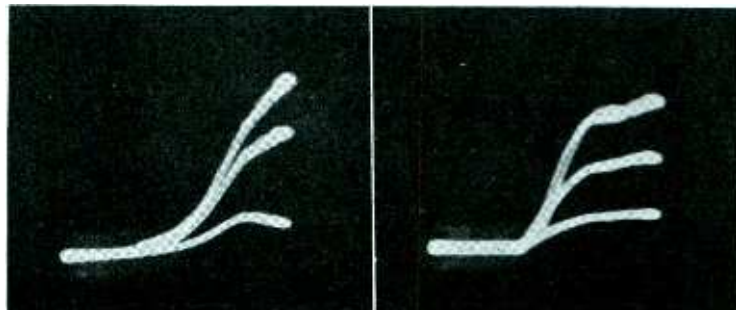

# A Practical Metal Detector

Originally developed for detecting metallic bits in cigars during manufacture, the tuned-bridge detector described in this article can be applied to a variety of industrial applications, and can be built readily from standard components

**T**HE device described in this article was developed for the purpose of inspecting finished cigars and automatically rejecting those that contain any particles of either magnetic or non-magnetic metals. The principal requirements were high detecting sensitivity, good stability under all conditions of temperature, humidity, dust and vibration, simple adjustments and compactness. The actual rejecting mechanism offered no difficulties, so it was mainly a problem of detection.

Among the devices for detection of metal which have been tried previous to this, the best known is probably the "Invisible Gun Detector" in prisons. This is an electromagnetic detector working directly on 60 cycles a-c. It is intended mainly for the detection of comparatively large objects of magnetic metal, requires delicate adjustments, indicates the presence of metal by the deflection of the beam of a cathode-ray tube and is obviously unsuitable for the stated purpose, although it possesses remarkable sensitivity.

The presence of metal can be detected by the change in inductance of a coil when the metal passes through its electromagnetic field or by the change in coupling between two coils when the metal passes through the field between the coils, or by a combination of these two methods. The change in inductance or in coupling is the result of eddy-currents set up in the metal, or of its magnetic permeability or of both. Preliminary tests were made by measuring the change in beat frequency between two r-f oscillators when the metal was passed through the coils of one of the oscillators. Frequencies of 100 kc to 1000 kc were used. The diameter of the coils was  $1\frac{1}{2}$ ". The results indicated that in order to be of practical value, the detector should operate on a minimum change of 10 cycles in 1000 kc

By **W. C. BROEKHUYSEN**  
*American Machine and Foundry Co.*  
Brooklyn, N. Y.

which would require two extremely stable oscillators. Moreover, it was found that for any oscillator frequency, there is a critical value for the diameter of steel pieces at which the magnetic and eddy-current effects balance each other and cause no change in the beat frequency. For these two reasons the beat frequency method was discarded and a tuned inductance bridge tried instead.

The fundamental arrangement of the coils is shown in Fig. 1, and a schematic circuit diagram in Fig. 2. Coils  $L_1$  and  $L_2$  form two arms of the bridge and are mounted on opposite sides of the driving coil  $L_3$ . Adjustable condensers  $C_1$  and  $C_2$ , in series with the coils  $L_1$  and  $L_2$  form the two other arms. The mid-point  $P_1$  of the condensers is grounded and the mid-point  $P_2$  of the coils is connected to the grid of the first amplifier tube. If  $L_1$  equals  $L_2$ ,  $C_1$  equals  $C_2$  and the r-f voltages  $E_1$  and  $E_2$  induced in  $L_1$  and  $L_2$  by  $L_3$  are equal and  $180^\circ$  out of phase, then the r-f voltage on the grid will be zero. A

piece of metal, passing through the three coils, will upset this balance twice, causing two r-f impulses on the grid which are amplified and detected in the usual manner. If  $L_1-C_1$  and  $L_2-C_2$  are tuned to exact resonance, or near-resonance, with the frequency impressed on the driver-coil, a small piece of metal will cause a relatively large change in r-f voltage across  $P_1-P_2$ . This voltage change may be the result of a change in amplitude of  $E_1$  or  $E_2$ , or of a change in their phase relation or of a combination of the two effects. It may reach a maximum at the moment the metal passes through  $L_1$  or  $L_2$  or when it is midway between  $L_1-L_3$  or  $L_2-L_3$ . All this depends on the frequency, tuning, spacing, coupling and on the material, size and shape of the metal particle. In most of the tests made, at a frequency of 1000 kc. the change was a maximum when the metal particle was in coil  $L_1$  or  $L_2$  and was caused mainly by a phase shift. This frequency was chosen mainly because it gives a sensitivity for non-magnetic metals comparable to that for steel and also because r-f transformers and other parts are readily available. An even higher and

View of the metal detector unit, showing tuning control and control relay on chassis front. The amplifier is mounted near pick-up coil

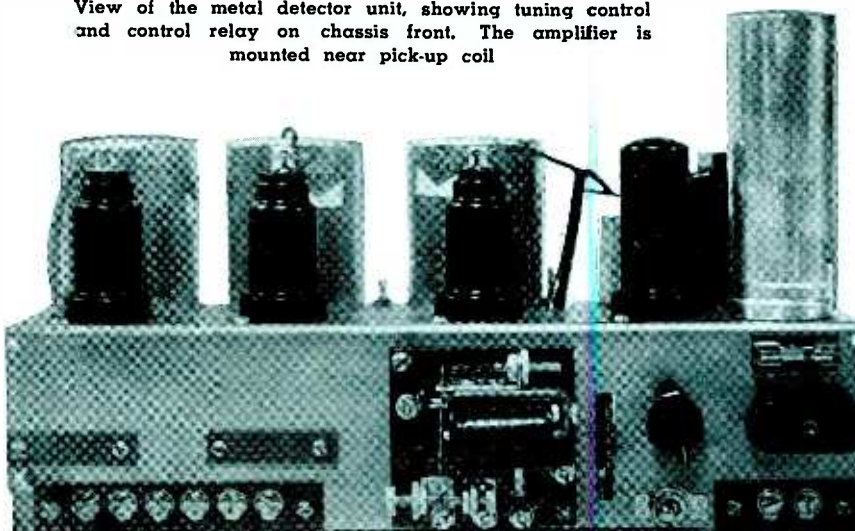

more uniform sensitivity could very likely be obtained at a higher frequency. This circuit is fundamentally much more stable than the beat frequency oscillator, because a change in oscillator frequency or amplitude affects both sides of the bridge equally and causes little change in voltage across  $P_1-P_2$  if the bridge is properly balanced.

The electrostatic effects of a relatively large object, like a cigar, passing through the coils, being far greater than the electromagnetic effects caused by a small piece of metal, it was found necessary to provide an electrostatic shield around the path of the cigars. This shield was made by covering the outside of insulating tube S in Fig. 1 with a large number of fine copper wires, parallel to the axis. These wires are connected to the external shield at both ends and are held in place with Bakelite varnish. Practically perfect electrostatic shielding was obtained in this manner without any serious loss in sensitivity.

The driver coil  $L_3$  is attached to a Bakelite washer which has three lugs projecting through slots in the external shield. Three rods, outside the external shield, pass through these lugs, supporting the washer and coil. One end of each rod is threaded and screwed into one of the end-

frames of the external shield. The position of the driver coil in relation to coils  $L_1$  and  $L_2$  may be changed by turning these rods. This, and the variable air condensers  $C_1$  and  $C_2$  are the only adjustments required to obtain perfect balance of the bridge. To eliminate any change in tuning of the two sides of the bridge, which might be caused by adjustment of the driver coil, two electrostatic shields are mounted between the coils. These consist of fine copper wires held radially against Bakelite washers with varnish. The outer ends of the wires are connected to the external shield. For the two condensers  $C_1$  and  $C_2$ , air-padding condensers are used, each with a fixed and a variable section. They are mounted in rubber to reduce the sensitivity to vibration.

The driver coil obtains its power from an oscillator. As any tendency of the oscillator to pull in step with the tuning of the bridge would seriously reduce the maximum sensitivity, the coupling between the bridge and the oscillator has to be reduced to an absolute minimum. For this reason, an electron-coupled oscillator is used.

Space limitations made it impossible to mount the oscillator, amplifier and power supply close to the bridge, so the apparatus was divided

into two parts, the pick-up unit containing the bridge and first amplifier tube, and the main or control unit. A step-down transformer is used to match the high out-put impedance of the oscillator to the low-impedance shielded connecting cable and low-impedance drive coil. Another step-down transformer is used in the plate circuit of the first amplifier tube to connect it through a second shielded cable to the first r-f transformer which has a low-impedance primary and is located in the main unit. The second r-f transformer has a high impedance primary. Its output is rectified by the diode section of the last tube and coupled to the grid of the triode section through a  $1 \mu f$  condenser. A sensitive relay is connected in the plate circuit of the triode. The oscillator coil and the secondaries of the r-f transformers are matched and tuned by a three-gang condenser. The power supply is of the universal type as used in 110-volt ac-dc receivers. The heaters of the tubes are connected in series.

The grid bias of the output tube is adjusted to a point where the relay armature is normally held in. Due to the capacitive coupling in the grid circuit, the relay current is not dependent on the steady value of the r-f voltage across  $P_1-P_2$ , but the relay will only drop out for a relatively

Fig. 3—Pick-up unit with rejecting mechanism, installed on cigar-rolling table

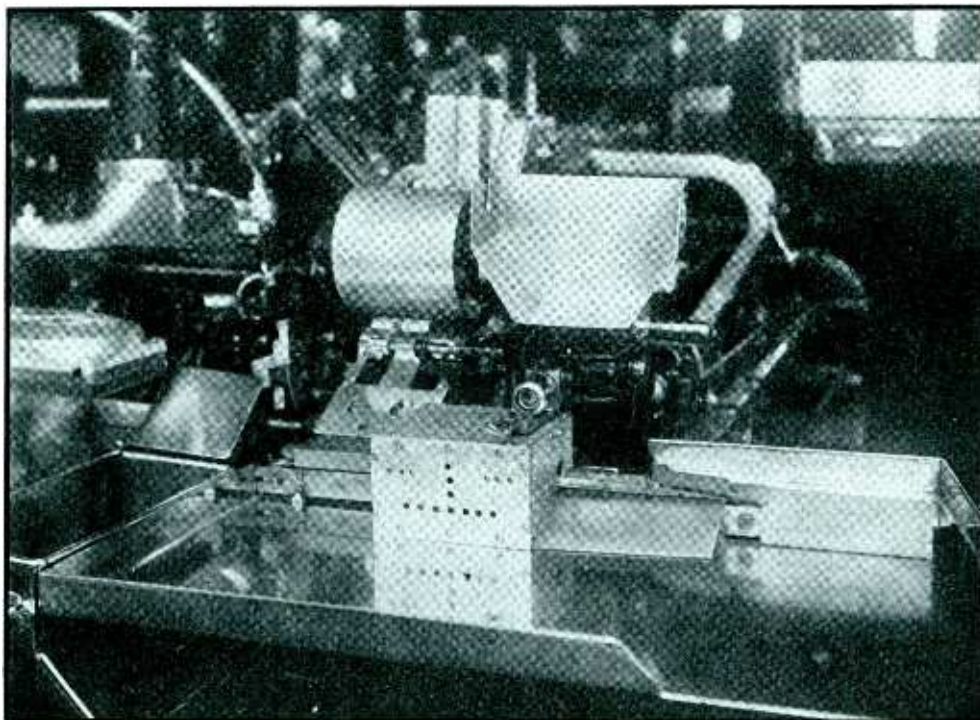

$$R_s = \frac{Rl}{2} \left[ 1 + \tan^2 bl + \frac{\tan bl}{bl} \right] + \frac{glZ^2}{2} \left[ 1 + \tan^2 bl - \frac{\tan bl}{bl} \right] \quad (21)$$

$$g_o = \frac{gl}{2} \left[ 1 + \tan^2 bl + \frac{\tan bl}{bl} \right] + \frac{Rl}{2Z^2} \left[ 1 + \tan^2 bl - \frac{\tan bl}{bl} \right] \quad (22)$$

If measurements are made at a frequency low enough so that  $\tan bl/bl$  does not differ much from unity, then  $L = L_s/l$  and  $C = C_o/l$ . Or if  $C_o$  and  $L_s$  are plotted against frequency the curves will be found to have horizontal asymptotes, which if divided by  $l$ , give  $L$  and  $C$  (see Fig. 1). In the same way from (21) and (22) if  $\tan bl$  is not too large  $R = R_s/l$  and  $g = g_o/l$ . The asymptotic method can be used here also, but in this case the asymptotes are not horizontal. It is of advantage to plot  $R_s$  and  $g_o$  on logarithmic paper, since  $R_s$  will vary as the square-root of the frequency and the asymptotes will be a straight line. The asymptote of  $g_o$  will be a straight line of slope unity if the phase-angle of the dielectric loss is constant.

The length of line to be chosen for measurement will depend upon the highest frequency at which measurements are to be made and upon the wave-velocity, or phase-factor, of the line. As a good practical rule  $bl$  should not exceed 0.9 at the highest frequency. Transmission lines may be divided roughly into two classes: (1) copper lines having very little dielectric between conductors, such as coaxial and open-wire lines, and (2) lines having a considerable amount of dielectric between conductors such as twisted-pair lines and coaxials in which the space between conductors is entirely filled with insulation. The wave-velocity of the latter is about half that of light, as compared with that of the first group, in which the velocity is substantially equal to the light-velocity. As a practical guide in this matter the following empirical rules may be employed: For non-dielectric lines,  $l = 140/f$ ; (feet, megacycles) (23) and for lines containing dielectric,  $l = 70/f$ . (feet, megacycles) (24) Table I shows the best length of line for measurements at various frequencies.

The components  $C_o$  and  $g_o$  of the open-circuit admittance are first measured with the remote end of the line open. Connect the line across the condenser terminals on the Q-Meter. If coaxial the outer conductor should

be connected to the ground terminal. Resonate the main tuning condenser of the Q-Meter and observe  $C_2$  and also  $Q_2$  of the circuit. Then disconnect the line, resonate the Q-Meter and observe the new tuning capacitance  $C_1$  and new  $Q_1$  of the circuit. The desired quantities may then be computed by:

$$C_o = C_1 - C_2 \quad (25)$$

$$g_o = 6.3 \times 10^{-6} f C_1 \left( \frac{Q_1 - Q_2}{Q_1 Q_2} \right) \quad (26)$$

where the  $C$ 's are in  $\mu f$  and  $f$  is in Mc. This procedure should be repeated at several frequencies in the desired range up to the limit expressed roughly by (23) or (24).

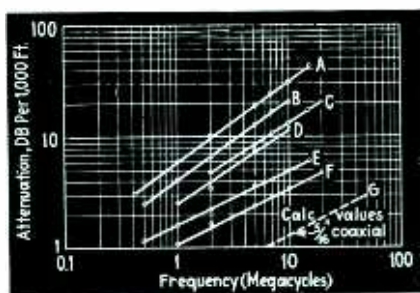

Fig. 2—Attenuation for typical lines

Quantities  $R_s$  and  $L_s$  are measured next with the remote end of the line short-circuited. This short should be of the lowest possible resistance and inductance and preferably soldered. For these measurements the line is connected in series with the inductance coil used with the Q-Meter. If coaxial the outer conductor should be connected to the "low coil" terminals of the Q-Meter. First resonate the main tuning condenser on the Q-Meter and observe  $C_2$  and also  $Q_2$ . Then short the line directly at its input terminals by means of a heavy copper bar of the lowest possible resistance and inductance. In some cases (at low frequencies or with low-resistance lines) the bar must be soldered in place for accurate results. Then reresonate the Q-Meter and observe the new  $C_1$  of the new  $Q_1$ . The desired quantities are then given by:

$$L_s = \frac{2.54 \times 10^4}{f^2} \left( \frac{C_1 - C_2}{C_1 C_2} \right) \quad (27)$$

$$R_s = \frac{1.59 \times 10^5}{f} \left( \frac{1}{Q_2 C_2} - \frac{1}{Q_1 C_1} \right) \quad (28)$$

where  $L_s$  is in  $\mu h$ ,  $R_s$  in ohms, the  $C$ 's in  $\mu \mu f$  and  $f$  in Mc. The measurements should be repeated at the same frequencies at which  $C_o$  and  $g_o$  were measured.

The surge impedance  $Z$  may be computed from (12) which, if  $L_s$  is in  $\mu h$  and  $C_o$  in  $\mu \mu f$ , becomes:

$$Z = 1000 \sqrt{L_s/C_o} \quad (29)$$

The attenuation factor  $a$  may be computed from (15) which, if  $L_s$  and  $C_o$  are expressed in the above units, may be written:

$$a = \frac{4340}{l} \left[ \frac{1}{1 + 3.94 \times 10^{-5} f^2 L_s C_o} \left( \frac{R_s}{Z} + g_o Z \right) \right] \text{ db/1000 ft.} \quad (30)$$

where  $l$  is in feet. The values of  $R$ ,  $g$ ,  $L$  and  $C$  may be obtained as described above.

Representative results of measurements on practical lines are shown in Figs. 1 and 2. The rise of the quantities (in Fig. 1) at the higher frequencies due to the line becoming electrically "long" is in evidence and also the method of determining the values of the line constants from the asymptotes is shown. Figure 2 shows the attenuation in decibels per 1000 feet for several lines as follows: A is a twisted-pair line resembling lamp-cord. B is a twisted-pair line of solid No. 12 conductors, covered with waterproof insulation. C is a coaxial comprising a central No. 12 (.080 in.) conductor and an outer flexible braid  $\frac{1}{2}$  in. in diameter, the space between being completely filled with soft rubber. Line D is a rubber-insulated line of the same general dimensions as C. Lines B and C are commercial products widely advertised as "low-loss" lines. Line E is a flexible coaxial containing interlocking beads of low loss insulating

TABLE I

Frequency Range (Mc)	Length of line (feet)	
	Non-dielectric	Dielectric
.1 to 1	140 ft.	70 ft.
1 to 10	14	7
1 to 50	2.8	1.4

material. Line F is a solid coaxial of 73 ohms surge impedance,  $\frac{5}{16}$  in. in diameter and insulated by Isolantite beads spaced 2 in. The calculated values for this line, based on copper loss, are shown in curve G. It will be seen that the twisted-pair and rubber insulated lines have relatively high losses and are suitable only for short runs or the lower frequencies. A line of the type F is quite suitable for outdoor use in conjunction with the flexible type E line for indoor use and for patching purposes.

# Television Receivers

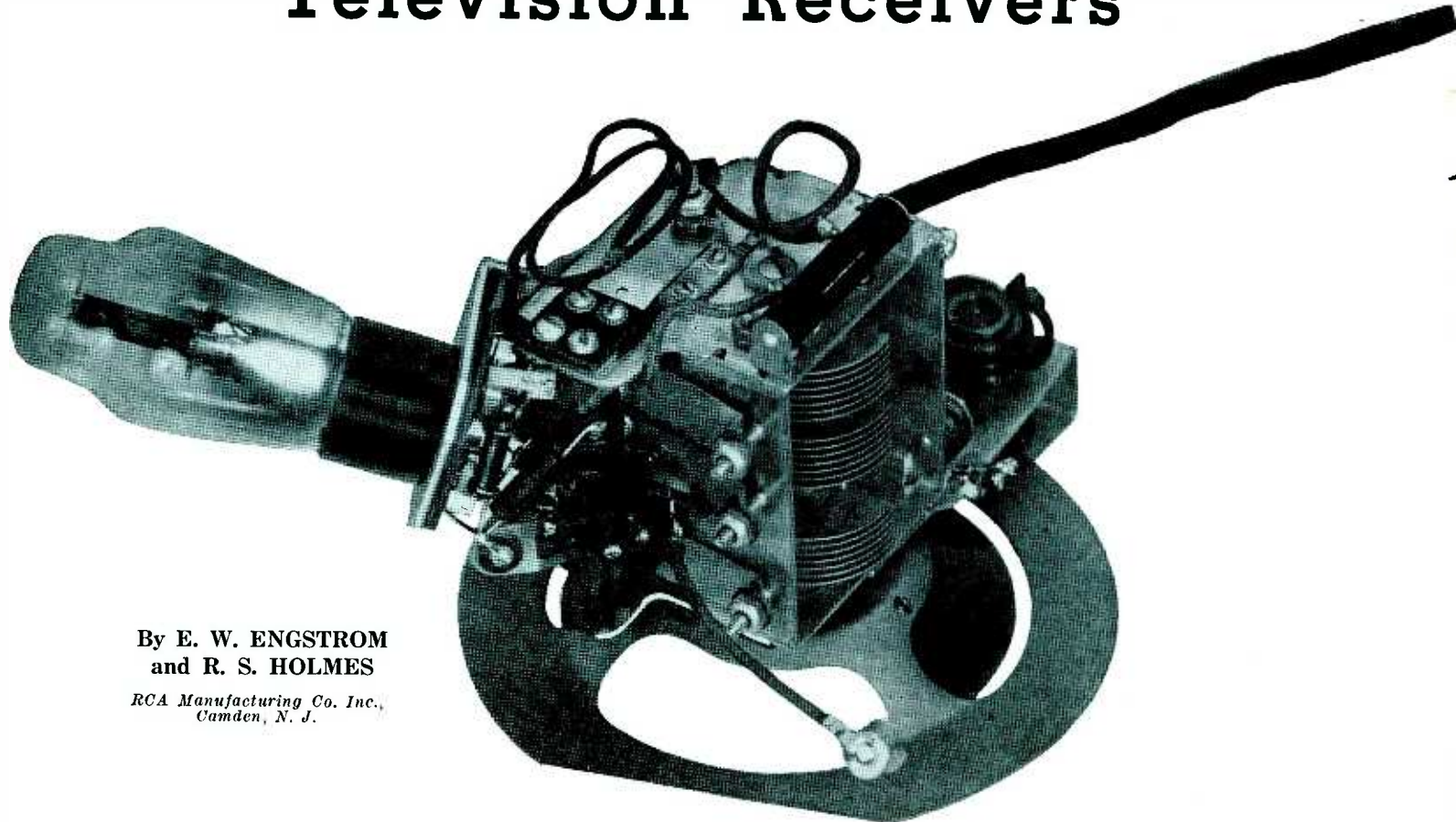

By E. W. ENGSTROM  
and R. S. HOLMES

RCA Manufacturing Co. Inc.,  
Camden, N. J.

Photograph of 3-section gang capacitor including tuning coils and oscillator tube

**T**IME is approaching when the radio engineer will be confronted with design problems on television receivers. The radio service man will desire to understand the principles of operation. The ambitious amateur will start experimenting with television circuits. It is with these aspects in mind that this series of articles has been prepared covering the fundamental factors involving the design and operation of television receivers. This first article considers some of the general problems and begins the analysis of the receiver.

In television we are concerned with a broadcast type of service in which adequate coverage of a service area is the prime consideration. The frequency of the radio carrier must be high enough to permit the relatively wide sidebands which are required, and so high that reflections from the ionosphere will not regularly occur. The second requirement is necessary to prevent multiple images caused by reflections from the ionosphere, and to permit duplication of frequency assignments with reasonable geo-

graphical separation of stations on the same channel. Further, in television we are concerned with a service requiring high signal strength at the receiver locations. Thus, the radio carrier must be at such a frequency so as to permit generation of adequate power. The carrier frequency must be such that the attenuation caused by obstacles on or near the transmission path is not too great, and so that the shadows cast by obstacles are not too sharp or too dense. All these considerations point to frequencies above and near 40 megacycles, for example, 44 to 108 megacycles, if television is soon to be practicable.

An advantageous channel arrangement for television is one such that

each transmission channel is complete within itself, that is, includes means for transmitting the video, synchronizing and sound signals. In such a system, the video and synchronizing signals may be transmitted on one carrier and the sound signals on another carrier. (The video and synchronizing signals are transmitted alternately.) One obvious advantage is that, being adjacent in frequency assignment, these two carriers have nearly identical propagation characteristics. With a fixed separation between the sound and picture carriers within each channel, simplified receiver operation can be obtained and a single control of receiver tuning is possible. Thus, it is possible to include both carriers

Fig. 1—Television broadcast channel allocations

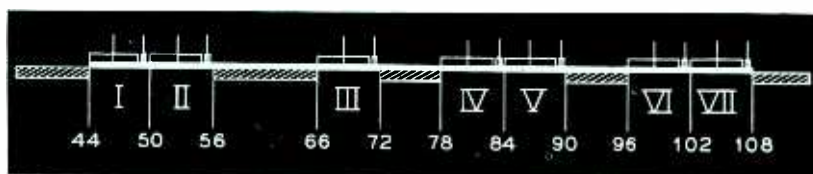

in the frequency band accepted by a single r-f system and separate them in two intermediate frequency channels following a single oscillator and heterodyne detector.

It has been found that the picture carrier and sound carrier should be of approximately the same power. This is determined by considerations of receiver selectivity for separating the picture and sound signals and considerations of the effects of noise on the reproduced image and sound.

As the number of scanning lines in the television image is increased, the frequency band required for transmission also increases. Thus, practical limits are encountered in amplifiers and transmission methods. Limits are also present in resolution and in signal-to-noise ratio of the Iconoscope and resolution of the Kinescope. The most definite limit is probably the frequency space available in the radio spectrum for television channels. Experience indicates that an image of 400 lines or more will provide satisfactory performance for home type television entertainment and results in characteristics which can be obtained in practice. A tentative standard of 441 lines has been adopted for the United States.

The frequency band required for a television image is proportional not only to the amount of detail trans-

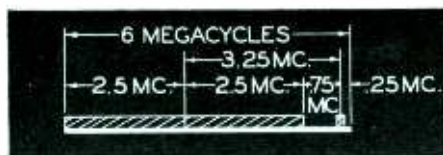

Fig. 2—Television channel make-up

mitted, but also to the rapidity with which it is transmitted, that is, the number of frames per second. The frame frequency and field frequency (for interlaced scanning) are determined by flicker and power supply frequency. To reduce the visual effects of a-c ripple in the reproduced image, the frame frequency should have an integral ratio to the power supply frequency; for example, a frame frequency of 30 per second is satisfactory for a power supply frequency of 60 cycles per second. To have satisfactory conditions with regard to image flicker, an effective frame frequency of 50 or more per second is required. This may be obtained without an increase in bandwidth by using interlaced scanning. By this method, odd numbered lines are scanned first and then the even numbered lines, with two fields of scanning for each frame. A tentative standard of frame frequency of 30 per second and a field frequency of 60 per second has been adopted for the United States.

For television channels, a tentative

standard has been adopted. This is for a channel 6 Mc. wide and with a spacing between picture and sound carriers of approximately 3.25 Mc. Such a channel arrangement is shown diagrammatically in Fig. 2. For such a channel, the sidebands of the picture transmitter may extend 2.5 Mc. on either side of the carrier, leaving a 0.75 Mc. guard band between the maximum frequency of the upper sideband and the sound carrier. The channels allocated for television broadcasting (in the lower frequency group) are shown by Fig. 1.

#### New Receiver Problems

The design of a television receiver is based upon many considerations which differ from those encountered in sound receivers. Two signals must be received and simultaneously utilized—picture and sound. The bandwidth required for the picture is many times greater than that required for sound broadcasting. For simplicity of operation, tuning should be uni-control for picture and sound. For many reasons, a superheterodyne circuit is well suited for meeting the receiver requirements.

For the radio frequencies planned for television transmission (above 40 Mc.) there will be practically no natural static. Man-made interference will, however, impose severe conditions. The wide picture fre-

Fig. 3—Block diagram of typical television receiver showing amplifiers for sound and video, detectors, AVC, deflecting circuits, cathode ray tube, etc.

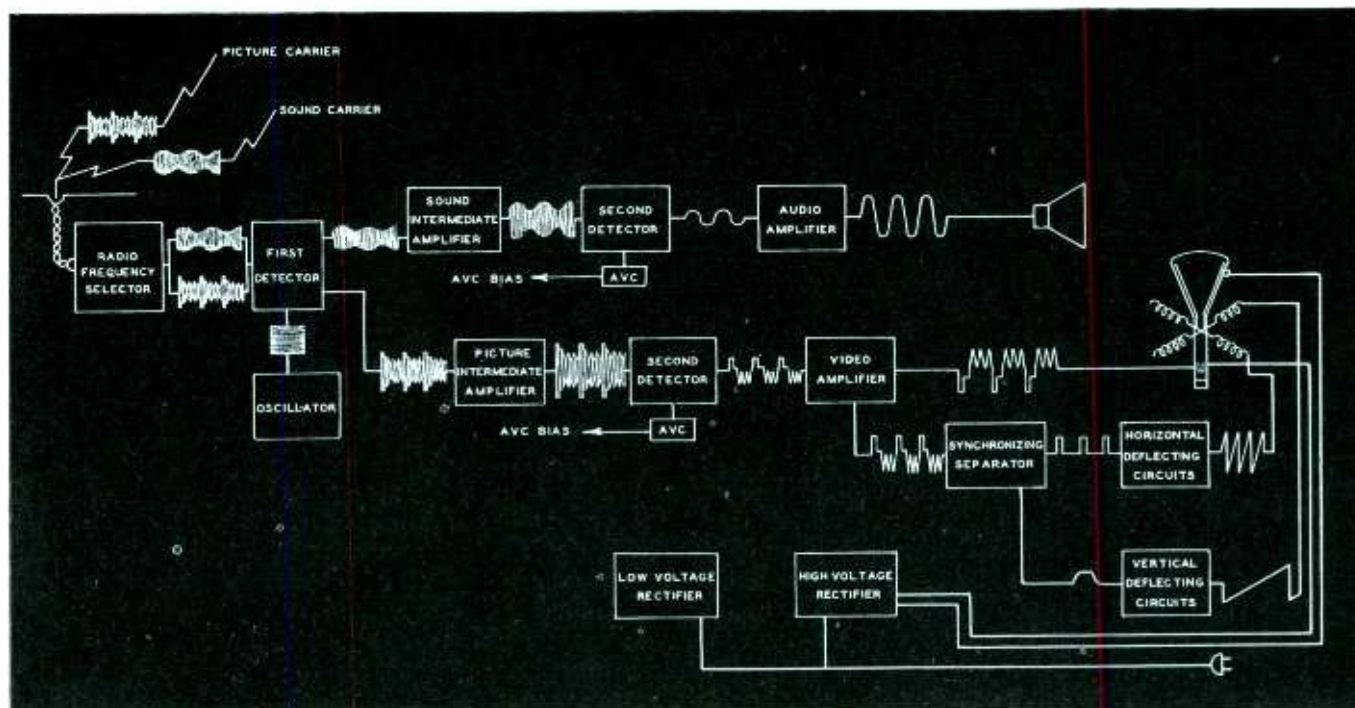

frequency bands make the receiver more susceptible to noise pickup than are more selective receivers. These factors point to the necessity of high signal levels at the receiver input, and consequently somewhat less sensitivity is required than is common for sound broadcast receivers.

The picture and sound carriers in all television channels will have the same frequency separation. Therefore, by properly choosing the pass bands of the two i-f amplifiers, both carriers can be heterodyned by a single oscillator. The picture intermediate frequency must be high because of the extremely wide v-f (video frequency) band. This wide frequency band means that more amplifier stages are required to compensate for the low gain per stage. Methods are employed to reduce the total frequency band which the receiver must pass and these contribute to economy in receiver design.

It has been found that if the receiver is designed to accept the carrier and one side band, rejecting a major portion of the other sideband, good performance can be obtained with very much greater economy. It is present practice where only one sideband is fully accepted by the receiver to accept the high frequency sideband and reject the lower. In the discussion of receiver design in these articles it is assumed that this economy is used.

Figure 3 is a block diagram of a typical receiver, showing the respective functions of the various parts of the circuit, and giving an indication of the wave shapes occurring there. Since both sound and picture are to be reproduced by this receiver, it is desirable to use a single antenna for picking up both carriers. Both signals are passed by the r-f circuits to the first detector where they are heterodyned to intermediate frequencies by the local oscillator.

These two bands of intermediate frequencies are amplified through their respective i-f amplifiers and rectified by separate second detectors. Separate automatic volume controls (as per Fig. 3) maintain the proper signal levels on the two detectors. The sound signal passes through a high fidelity audio amplifier to the loudspeaker.

The rectified picture, or video, signal is amplified through the v-f amplifier and impressed on the control grid of the Kinescope. This ampli-

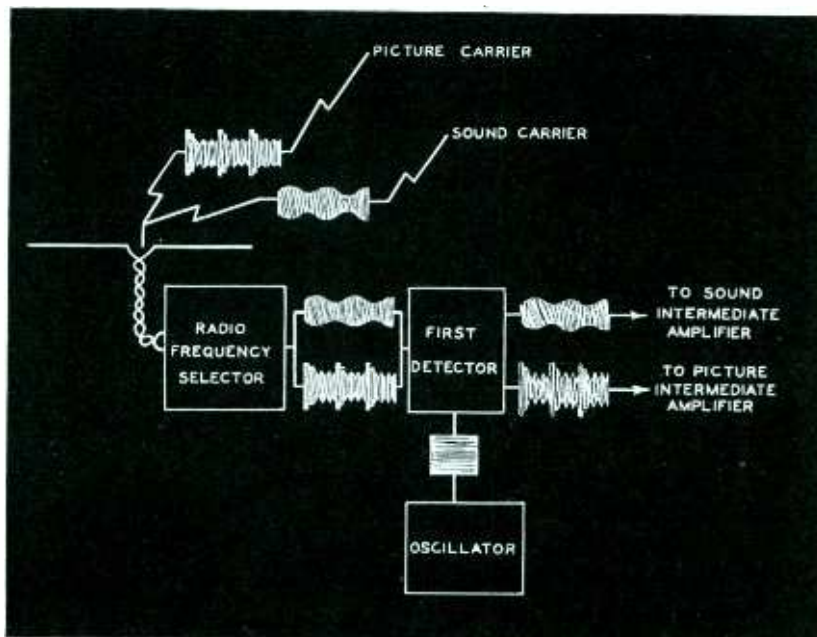

Fig. 4—Portion of television receiver reviewed in this discussion

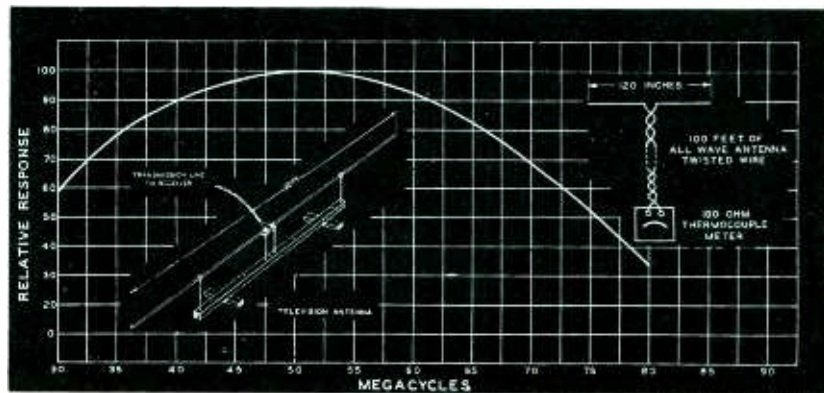

Fig. 5—Dipole antenna and its response as a function of frequency

fier must be so designed that it will pass the full video frequency band of approximately 60 cycles to at least 2,500,000 cycles with negligible amplitude and phase distortion. An output of the order of 50 volts peak to peak is usually required on the Kinescope grid.

The input to the synchronizing separator circuit is also obtained from the video frequency amplifier at some point where the amplitude and polarity of the video signal are correct, but ahead of the contrast (video gain) control, so that the synchronizing is not affected by the video contrast control adjustment.

The synchronizing separator must separate the synchronizing pulses out of the composite video signal, and then separate the horizontal and vertical pulses from each other and impress them on the deflecting circuits in the proper amplitude and polarity

to synchronize the deflecting oscillators.

The deflecting circuit consists essentially of three parts. First an oscillator which generates pulses of large amplitude, synchronized by the incoming synchronizing signal; second a circuit for changing the large (voltage) pulse into a voltage of sawtooth wave shape, and third, a circuit for changing the sawtooth of voltage into a sawtooth of current through the deflecting coils, to deflect the Kinescope electron beam.

Both deflecting circuits perform essentially the same functions, but the circuit arrangements and constants are different because of the great difference in operating frequency, i.e. 60 per second for the vertical and 13230 per second for horizontal, (30 frames, 441 lines).

Other components of importance in the receiver are the power supplies,





# PRECISION

## WIRE WOUND RESISTORS



### A SIZE and SHAPE for EVERY MOUNTING PROBLEM

In IRC Precision Wire Wound Resistors you get time-tested resistance dependability for equipment that must be perfect in every detail. Their features include . . .

- NON-INDUCTIVE OR INDUCTIVE WINDINGS
- PERMANENTLY LOW NOISE LEVEL
- ACCURACY AS HIGH AS 1/10 OF 1%

LONGER LIFE      GREATER STABILITY

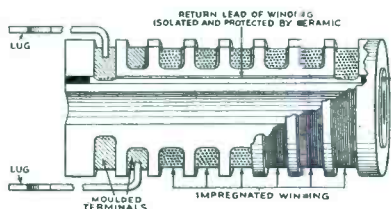

### NEW PROTECTED END TERMINAL DESIGN

As illustrated above, IRC Precision Resistor types WW-12, WW-13 and WW-14 provide an ingenious method for bringing both terminals out at one end. The resistance wire is returned internally through the ceramic, yet completely insulated from windings or mounting bolts. Thus the problems of shorting and breakage at the terminals, caused by exposure of resistance wire, are definitely eliminated.

Write for catalog.

## INTERNATIONAL RESISTANCE COMPANY

403 NORTH BROAD STREET, PHILADELPHIA, PA

In Canada 187 Dufferin Street, Toronto, Ontario

MAKERS OF RESISTANCE UNITS OF MORE TYPES, IN MORE SHAPES, FOR MORE APPLICATIONS THAN ANY OTHER MANUFACTURER IN THE WORLD

# NOW



## After years of development

Mallory introduces to the radio industry completely standardized, low cost, dry electrolytic capacitors. Complete data is available to all radio design engineers.

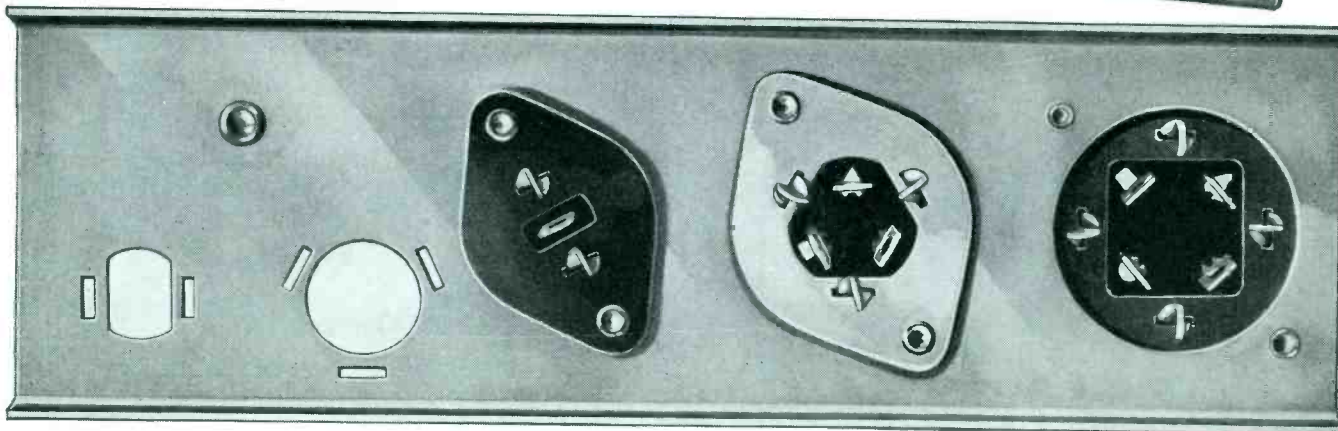
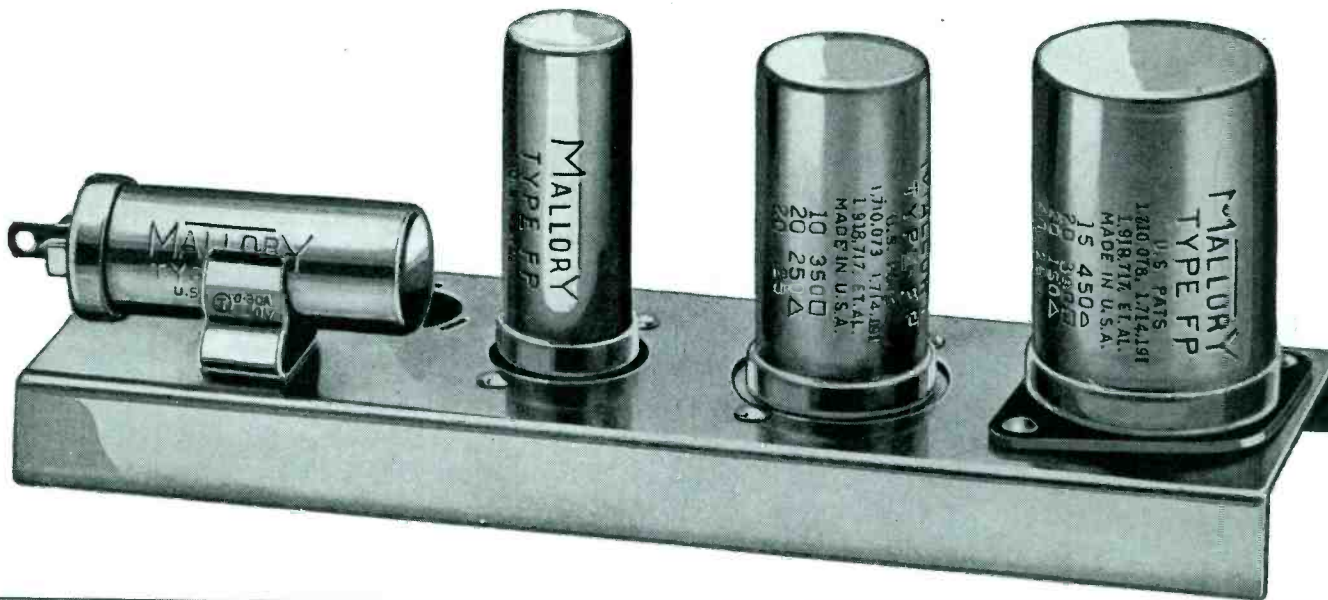



*half the* **SIZE**

*but*

**Better**

**Performance**

**Than Ever**

Mallory made no compromise with performance in the development of these new capacitors. They completely alter the range of possibilities in radio chassis design.

- Completely Standardized
- Costs Lowered up to 50%
- 50% Reduction in Size
- Revolutionary Self-Contained Mounting
- Uniformly Low RF Impedance in Multiple Units
- Minimum Coupling Effect in Multiple Units
- New Type Surge-Proof Separators
- New Fabricated Anode Material



*Products for* RADIO, ELECTRICAL, AUTOMOTIVE *and* INDUSTRIAL FIELDS

**P. R. MALLORY & CO., Inc., INDIANAPOLIS, INDIANA**  
CABLE ADDRESS — PELMALLO

# TUBES AT WORK

## Photochemical Combination Used as a Switch Control

By JOHN H. JUPE

ONE OF THE MOST interesting exhibits at Physical Society's Exhibition, recently held in London, was a new type of photoelectric switch. It depends on a photochemical action well known to all chemists, namely, that if hydrogen and chlorine be mixed and exposed to light, combination takes place, the rate of combination being dependent on the intensity of the light. With sunlight, the action is instantaneous. In darkness there is none at all.

To make practical use of this phenomenon, a relay has been designed consisting of a transparent container with electrodes contained in it and partly filled with a solution of hydrochloric acid and calcium chloride. One wall of the chamber is in the form of a flexible diaphragm operating directly on a switch or by squeezing a tube of mercury.

The cycle of action is as follows. Electrolysis takes place when direct current is passed through the cell; hydrogen and chlorine gases are produced and eventually close the local circuit by reason of the gas pressure on the flexible wall. A high resistance is then put in series with the electrodes to prevent further electrolysis. If now, the cell is in darkness the local circuit will remain closed, but upon exposure to light, the gases will recombine, the pressure fall and the switch open. Above a certain light intensity the gases will recombine as fast as they are formed and consequently no pressure rise will take place.

These switches have been used to operate lights at dusk in a similar way to the more usual photocells and are particularly suitable for use on low voltages such as are met with on automobiles. A number of them are in use in France on taxicabs.

No internal destruction takes place provided that the cells are polarised continuously. This requires a small dry cell to be connected across the electrodes during shipping and storage.

• • •

## An Improved Meter Shunt Circuit

By VERNE O. GUNSOLLEY  
Minneapolis, Minn.

WHEN IT IS DESIRED to make a low range ammeter cover a higher range, the first thought likely to come to mind

is that illustrated in Fig. 1. In this hook-up it is evident that the safety of the meter depends entirely upon the perfection of the contacts on the switch, and that any variation in the resistance of the contact will cause variations in indication, especially on the high current ranges. Such a method of shunting results in many burned out meters, especially if switching is done while the current is on. The fuse *F* will protect the meter, but due to its resistance a shorting switch *B* must be closed while taking readings. Outside of these disadvantages, the circuit has the advantage that it presents a progressively lower resistance to the external circuit as the range is increased, that is, for ten times the current, the circuit presents one tenth the resistance. This

feature is of utmost value when measuring high currents due to low voltages in low resistance circuits, as for example, in the voice coil circuit of a 5-ohm loudspeaker, where ten watts of power would represent a current of 1414 ma. A thermoammeter of 115 ma. range and having a resistance of 5.2 ohms when shunted to have twenty times this range, or 2300 ma., would present a resistance of  $5.2/20 = 0.26$  ohm only, in series, thus making the effective load on the output transformer 5.26 ohms instead of 5 ohms. Due to the broad characteristics of the power curve on most output tubes, the effect of the meter in series with the voice coil would be negligible, and if not, corrections could be easily made by calculation. However, if the meter shunt were not increased in direct ratio, then the effects of series insertion might be undesirably great.

In an effort to fortify the meter against burnout, the circuit illustrated in Fig. 2 is sometimes, though rarely used. In this circuit, the main shunt is designed to have a rather high voltage (Continued on page 42)

## NEW SUPER-POWER X-RAY INSTALLATION



Above is the control panel of the installation, at which the strength of the radiation is measured and controlled

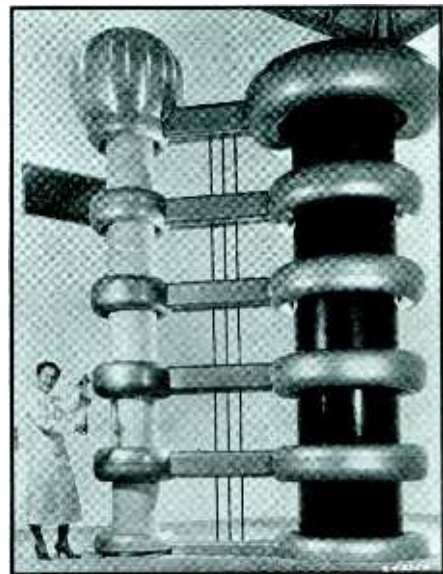

At the Los Angeles Institute of Radiology, a new million-volt X-ray installation has recently been completed. Above is the upper half of the X-ray tube, with corona shields to regular intervals along the transformer (right) and porcelain tube housing



The treatment room is completely isolated by lead shields. The patient is observed through a periscope, which prevents exposure of the operator to the radiation

# Solving a Rectifier Problem

By REUBEN LEE

Westinghouse Elec. & Mfg. Co.  
Chicopee Falls, Mass.

IN ANY particular engineering difficulty, the engineer usually first encounters the difficulty, then analyzes it to determine the cause, and finally, by applying his new knowledge, seeks to remove the cause. But in the analysis, he may have to go back to fundamental principles and carefully reason his way out. At least, it was so in the case of a rectifier having over 40% regulation instead of the required 5%; the lower figure was obtained finally without any material increase in size. For the sake of logical order, the analysis is here presented first and the application later.

The regulation of a rectifier comprises three distinct components:

1. The d-c resistance or IR drop.
2. The commutation reactance or IX drop.
3. The condenser charging effect.

The first component can be reduced to a small value in most cases by the use of tubes, transformers, and reactors having low resistance drops. Mercury vapor tubes are of noteworthy usefulness in this respect, as the internal voltage drop is low and almost independent of load current variations.

Commutation reactance can be kept to a low value by proper transformer design, particularly in those cases where the ratio of short-circuit current to normal load is high. Rectifiers for radio apparatus virtually all fall in this class.

If the rectifier had no filter condenser, that would be the end of the matter. The rectifier would deliver the average value of the rectified voltage wave, less regulation components 1 and 2. But with a filter condenser, there is the ever present tendency at light loads for the condenser to charge up to the peak value of the rectified wave. At zero load, this amounts to 1.57 times the average value, or a possible regulation of 57% in addition to the other components, for single phase full wave rectifiers. This effect is less in magnitude for polyphase rectifiers, al-

though it is present in all rectifiers to some extent.

The discussion here will be limited to the common rectifier circuit shown in Fig. 1. In this diagram, the single phase full wave rectifier output shown in Fig. 2 is delivered to a choke input filter and thence to a variable load. In such a circuit, the filter reactor keeps the condenser from charging to a value greater than the average  $E_1$  of the rectified voltage wave, provided the load resistance is low enough. There is a value of load at which the condenser charging effect sets in for a given filter. At lighter loads than this, the d-c output voltage rises above the average of the rectified wave, as shown by the typical regulation curve of Fig. 3.

Starting at zero load, the d-c output voltage  $E_0$  is 1.57 times the average of the rectified wave. As the load increases, the output voltage falls rapidly until the current  $I_1$  is reached. For any load greater than  $I_1$ , the regulation is composed only of the two components IR and IX. It is good practice to use a bleeder load  $I_1$  so that the rectifier operates between  $I_1$  and  $I_2$ .

The filter elements bear an important relation to each other and to the load  $I_1$ , and this relation is arrived at as follows:

The rectifier pulsating output voltage delivered to the filter may be resolved into d.c. plus superposed a.c. fundamental and harmonic components. The filter, if it is effective, attenuates the a-c components so that across the load there exists a d-c voltage with a small ripple voltage superposed. The unattenuated a-c components are of comparable magnitude to the d-c component. Standard books on rectifiers\* give the values of these a-c components in percentage of the d-c component as follows:

Rectifier	Fund. Freq. Supply	Ripple Freq. times	A-C Fund.	2nd Har.	3rd Har.
1-Ph. Full Wave	2	2	66.7%	13.3%	5.7%
3-Ph. Half Wave	3	3	13.3%	3.2%	1.4%
3-Ph. Full Wave	6	6	5.7%	1.4%	0.6%

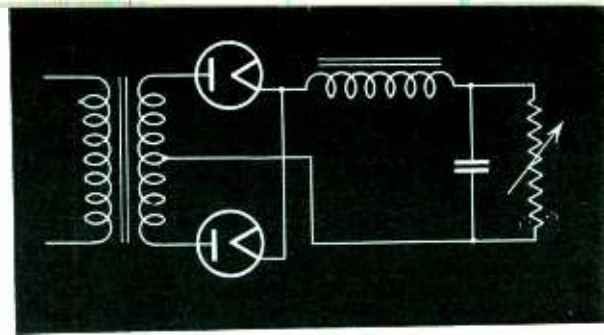

Fig. 1—Fundamental rectifier circuit

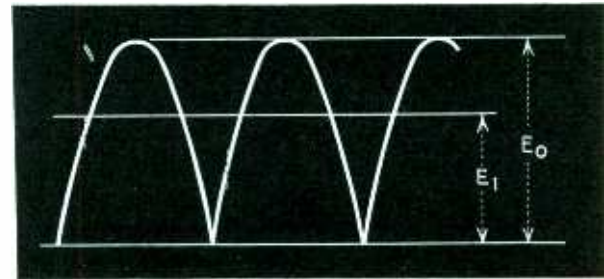

Fig. 2—Wave form of the circuit of Fig. 1.

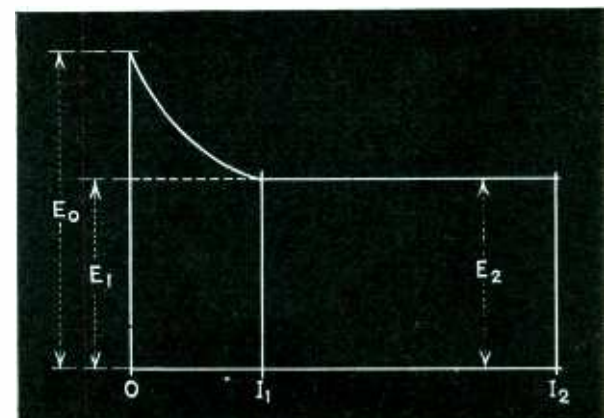

Fig. 3—Regulation curve of typical rectifier

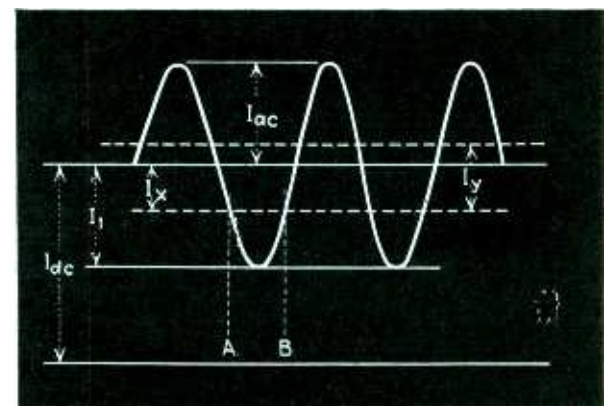
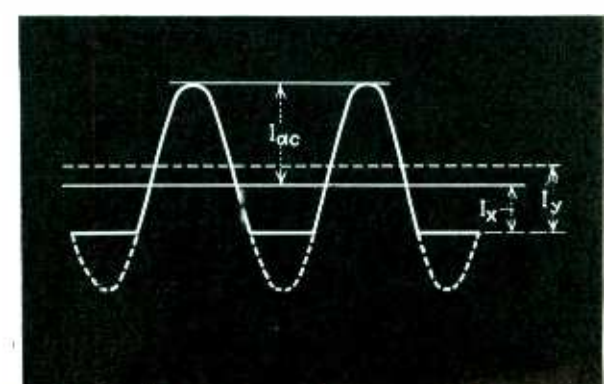

Fig. 4—A-c and d-c components of rectifier output

Fig. 5—Effect of increasing load resistance of rectifier



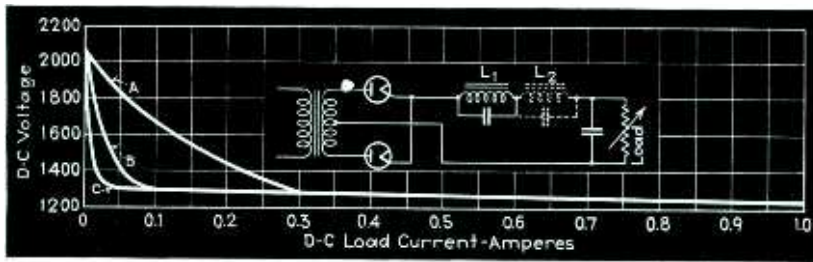

Fig. 6 (insert) and Fig. 7—Use of tuned choke and the result on regulation. A, Conventional circuit; B, one tuned choke; C, two tuned chokes

A filter of the type shown in Fig. 1 attenuates the harmonic components much more than the fundamental component, and since the harmonics are smaller to begin with, the main function of this filter is taking out the fundamental a-c component. This has a value, according to the table, of 66.7% of the average rectified d-c voltage. Since this component is purely a-c it encounters only a-c impedances in its circuit. If, in Fig. 1, we designate the choke impedance as  $X_L$ , and the condenser impedance as  $X_C$ , both at the fundamental ripple frequency, the impedance to the fundamental component is  $X_L - X_C$ , the load resistance being negligibly high compared to  $X_C$  in an effective filter. The d-c voltage, on the other hand, produces a current limited mainly by the load resistance, assuming the choke IR drop is small.

Currents due to the a-c and d-c components are shown in Fig. 4, with the ripple current  $I_{ac}$  superposed on the load direct current  $I_{dc}$ . If the direct current be made smaller by increased load resistance, the a-c component is not affected because load resistance has practically no influence in determining its value. Hence, a point will be reached as the d-c load current is diminished, where the peak value of ripple current just equals the load direct current. Such a condition is given by d-c load  $I_l$  which is equal to  $I_{ac}$ . If the d-c load is reduced still further, say to the value  $I_x$ , no current flows from the rectifier in the interval A-B of each ripple cycle. The ripple current is no longer a sine wave, but is cut off on the lower halves, as in the heavy line of Fig. 5. Now the average value of this current is not  $I_x$  but a somewhat higher current  $I_y$ . That is, the load direct current is higher than the average value of the rectified sine wave voltage divided by the load resistance. The amount of voltage increase necessary for this increased current is made available by the ten-

dency of the condenser to charge up to the peak of the voltage wave between the intervals A-B. Hence, the term *condenser effect* which is applied to the voltage increase. The limiting value of this effect is obviously the peak value of the rectified voltage, which is 1.57 times the sine-wave average, at zero current load.

To keep the condenser effect from happening the choke must be large enough so that  $I_{ac}$  is equal to or less than the bleeder current  $I_l$ . This consideration leads directly to the value of choke inductance. The bleeder current  $I_l$  is  $E_l/R_l$ , where  $R_l$  is the value of bleeder resistance. The ripple current is the fundamental ripple voltage divided by the ripple circuit impedance, or

$$I_{ac} = 0.667 E_l / (X_L - X_C).$$

Equating  $I_l$  and  $I_{ac}$ , we have

$$R_l = \frac{X_L - X_C}{0.667} \dots \dots \dots (1)$$

Here we see that the value of capacity reactance also has an effect, but it is minor, relative to that of the choke, else the filter would not do much filtering. Hence, in a well designed filter, the choke reactance  $X_L$  is always high compared to  $X_C$ . So the predominant element in fixing the value of  $R_l$  (and of  $I_l$ ) is the filter reactor. By making this reactor larger and larger, we can make the bleeder power necessary for good regulation smaller and smaller.

Now for the application. The rectifier in question had the regulation curve A shown in Fig. 7. The current which has been called  $I_l$  in the foregoing was 300 ma. and full load was 1.0 amp. The bleeder load was 50 ma., and increasing it to 300 ma. was out of the question; the rectifier would not deliver the extra power. Increasing the size of the filter choke was prohibitive because of space limitations. Besides, the increase in inductance would have to be accompanied by no increase in choke resistance, as the IR drop alone accounted for nearly 5% regulation,

the amount desired for proper amplifier operation. Mercury vapor tubes were used; all the usual design precautions had been taken. Still stood the ominous 40% regulation between bleeder and full load.

A glance at equation (1) shows that the bleeder resistance depends upon the filter choke impedance. If this impedance could be increased without increasing the size of the choke, the problem would be solved. The impedance of any inductance can be raised by tuning it, so this was tried. The choke ( $L_1$ ) was tuned to the ripple frequency as shown in Fig. 6 and a new regulation curve resulted at light loads, that shown by curve B in Fig. 7. This was a decided improvement, but still exceeded the desired 5% regulation between 50 ma. and 1.0 amp.

The value of bleeder current now needed for 5% regulation was 110 ma. A choke having a fair amount of inductance at this value of current has only a small fraction of the size of the 1.0 amp. filter choke. Such a choke ( $L_2$ ) was placed in series with the main filter choke and was likewise tuned as shown dotted in Fig. 6. The regulation curve with both tuned chokes was as shown by curve C of Fig. 7 and was within the 5% regulation limit.

All three added elements were of such small size that they could be located easily among the larger rectifier elements. For instance, the main filter choke was tuned with 0.25  $\mu f$  and the small choke with 0.6  $\mu f$ , as compared to 12  $\mu f$  across the load.

Another feature observed in this instance was the fact that the load ripple decreased as well as the regulation. This was to be expected, because of the increased filter choke impedance.

Hence it follows that if a filter is originally designed to use tuned chokes, these advantages accrue:

1. For a given value of permissible regulation, less bleeder power and/or smaller filter choke are needed.
2. For a given amount of bleeder power, less regulation and ripple result and/or smaller filter choke is needed.
3. The use of smaller filter chokes makes it easier to obtain the desired regulation by reducing the choke d-c resistance.

\* Prince & Vogdes, "Mercury Arc Rectifiers and Circuits," page 92.

"..AND CINCH INGENUITY  
TURNED THE TRICK!"



The story of a plug button that  
became a condenser mounting

## WHEN IS A PLUG BUTTON

When is a plug button used? Introduced by Cinch to plug holes in the chassis when a standard chassis is used for a variety of sets and hook-ups. Also for grounding cable connectors. Cinch engineers have expanded plug button uses. Mentioned here is an outstanding example of when it was more than a plug button, or,

## . . . NOT A PLUG BUTTON

To serve a certain set requirement for wiring through the chassis, the plug button became a condenser mounting unit. Cinch parts are the most efficient for the purposes designed but in a number of instances they have been adapted most satisfactorily for other uses. That's Cinch Engineering, "Ingenuity"—and of course, for users, the acme of efficiency and economy.

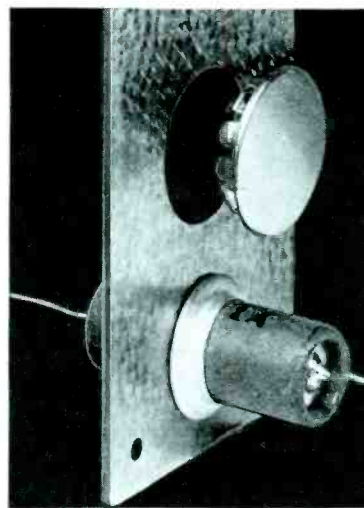

Cinch and Oak Radio Sockets are licensed under H. H. Eby socket patents

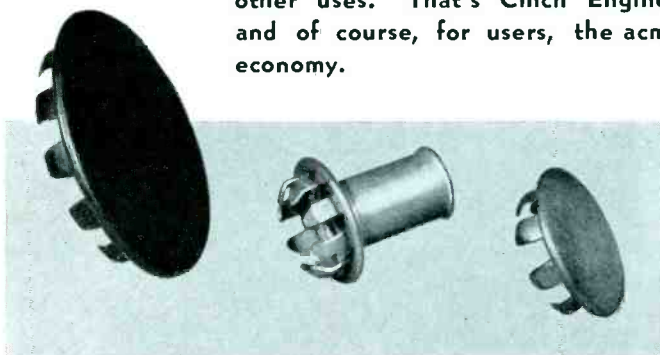

# CINCH

**MANUFACTURING CORPORATION**  
2335 WEST VAN BUREN STREET, CHICAGO, ILLINOIS  
SUBSIDIARY OF UNITED CARR FASTENER CORPORATION, CAMBRIDGE, MASS.

# AUDIO-FREQUENCY COMPONENTS

for Electronic Applications



Left: AmerTran De Luxe Audio Frequency Components in two types of standard mountings.

CONTINUOUS research work since the early days of broadcasting has made and maintained the AmerTran trade-mark a symbol representing the ultimate in transformers for audio-frequency circuits. Throughout the world engineers associated with broadcasting stations, recording studios, apparatus manufacturers and laboratories use AmerTran equipment for dependable results in all types of audio amplifiers.

May we send you Bulletin 1002C. You will find descriptive data covering five complete lines of audio components—a type to meet nearly every requirement of rating, price, frequency characteristic and physical size. And, if standard units do not satisfy, we are equipped to furnish special designs for unusual applications.

**AMERICAN TRANSFORMER COMPANY**

178 Emmet Street, Newark, N. J.

# AMERTRAN

Manufactured Since 1901 at Newark, N. J.

# TRANSFORMERS



### PRODUCTS

American Transformer Co. manufactures transformers for every industrial, electronic and laboratory application in sizes up to 10,000 Kva. and for potentials up to 132 Kv. Other products: voltage regulators, test sets, rectifiers.

## Tubes At Work

(Continued from page 36)

age drop, even on low currents. The meter is connected to the suitable tap for the range desired. This circuit while entirely satisfactory for high resistance circuits, is totally unsuited for making voice coil measurements. The reasons are obvious from the previous

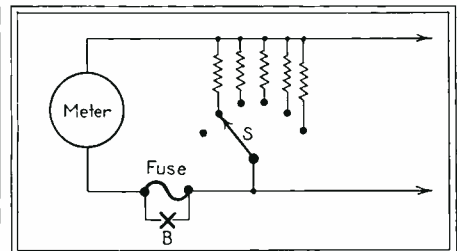

Fig. 1—Elementary shunt circuit

calculations. It is further evident that the meter cannot be used on its lowest, or fundamental range, because of the permanent shunting effect of the main shunt.

As a more convenient modification of the circuit in Fig. 2, the circuit in Fig. 3 is the one now almost universally recommended. In this circuit all the shunts are in series, and the meter is permanently connected to them.

The two principal disadvantages of this circuit lie in the fact that the full

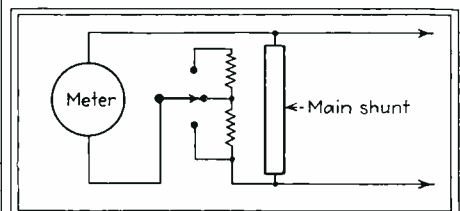

Fig. 2—Circuit for safeguarding meter

sensitivity of the meter cannot be employed, since it is permanently shunted, and the voltage developed across shunt A has to be high enough to make up for the drop that results in shunts B and C before the current gets to the meter. With this arrangement it is nec-

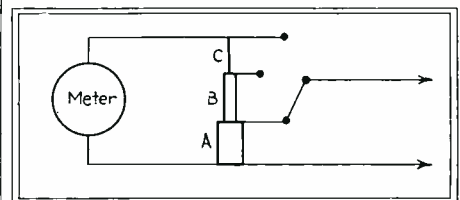

Fig. 3—Improved form of safeguard circuit

essary to calibrate the meter with the shunts in place. In the circuit in Fig. 1, any calibrated meter may be multiplied by any practicable amount and yet the lowest range may be used.





## Elevator Gets a Lift from SYNTHANE

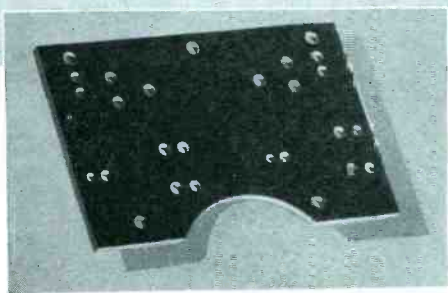

**H**AVE YOU ever stopped to think—when you've stepped into an elevator—that a maze of hard working electrical equipment is responsible for its daily reliability? This equipment is insulated with *Synthane* because *Synthane* has four properties that

elevator manufacturers want—mechanical strength, high dielectric strength, wear resistance and—dependability. . . . You can get this *same* combination of properties or *almost any other combination you desire*, for *Synthane* has an unusually broad *combination* of physical, electrical, chemical, and mechanical properties. *Synthane* is a dense, solid material, tough, strong and light in weight—an excellent electric insulator—with a low power factor, low moisture absorption, high dielectric

strength and low dielectric constant. It's chemically inert and corrosion resistant. It machines easily. *Synthane* is often the most economical material to use through lowered production costs, better product performance, dependable adherence to standards. Why not write for data on *Synthane*, giving us your requirements? We might help you make more money.

SYNTHANE CORPORATION  
EAST RIVER ROAD OAKS, PENNSYLVANIA

SHEETS • RODS • TUBES • FABRICATED PARTS • SILENT STABILIZED GEAR MATERIAL



**SYNTHANE BAKELITE-LAMINATED**

**SYNTHANE**  
Bakelite —  laminated

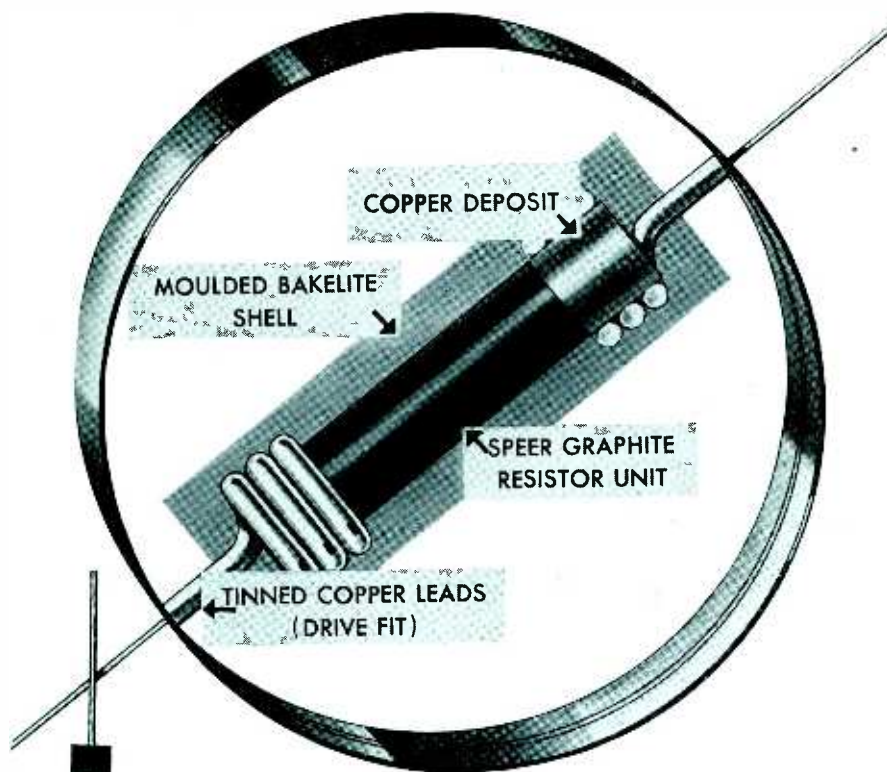

# Hard to Magnify

It is hard to magnify either the importance of uniformity or of the means by which it is insured in SPEER Insulated Resistors.

Forty years devoted exclusively to the production of carbon products of quality have developed methods and tests which insure a degree of uniformity on which regular buyers of SPEER Insulated Resistors rely. SPEER materials, construction, careful assembly, and rigid testing produce resistors of known characteristics that remain unchanged by heat, cold, humidity, or the severest service conditions to be expected.

Millions of SPEER Insulated Resistors per year are regularly used by leading manufacturers of receiving sets and other electronic devices. Samples and complete Specifications will be sent to manufacturers promptly on request.

**SPEER CARBON COMPANY**  
ST. MARYS, PA.



# SPEER INSULATED RESISTORS

This is a very great advantage around the laboratory.

In order to retain the safety of the method in Fig. 3, and yet procure the lowest possible resistance and the cali-

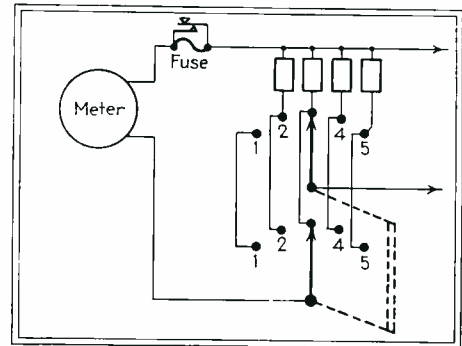

Fig. 4—Gang-switch system, which combines advantages of Figs. 1 and 3

brating advantages in Fig. 1, the circuit in Fig. 4 was devised. Observation will reveal that there is no possible way to burn out the meter, other than to have the shunts themselves fail. If the meter arm fails to make contact, then only the meter circuit opens, causing no harm. If the current arm fails to make contact, then only the external circuit is opened; and the load is again taken off the meter. There is no com-

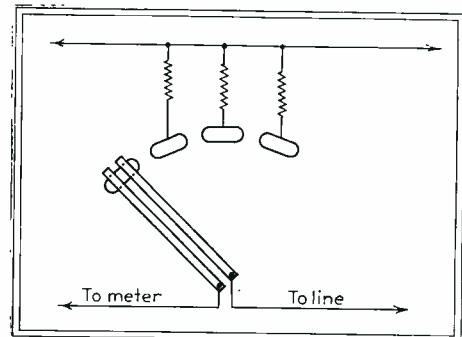
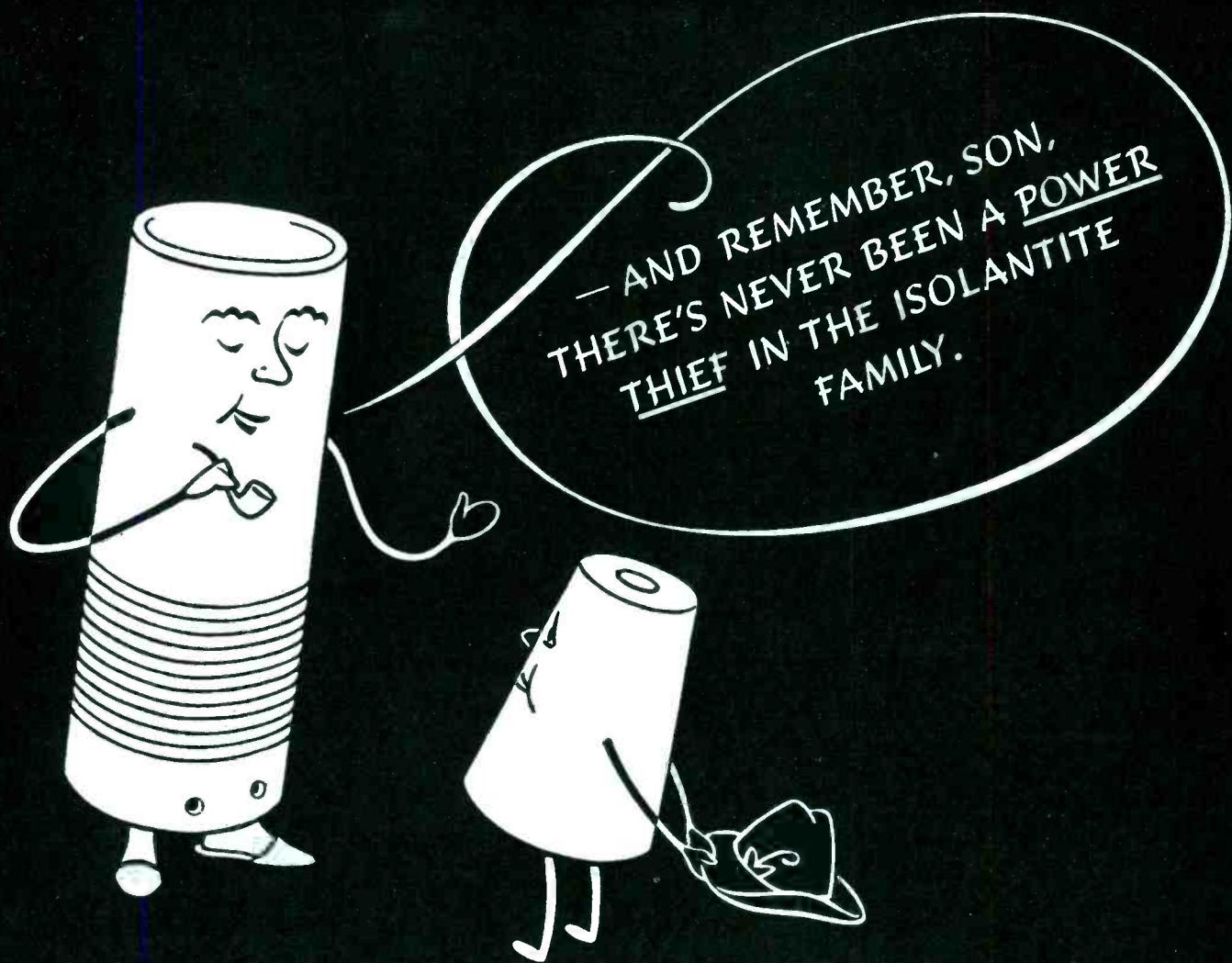

Fig. 5—Method of minimizing switch lead reactance effects

ination of make and break in either switch that can result in the loss of the meter. A fuse in this circuit is essential only to provide against overload in the external circuit.

In Fig. 4, the switch illustrated is of the two-gang type, and bus wiring is used between contacts bearing the same number. The essential precautions in the construction of such a circuit are: First, be sure that the bus wiring is more than adequate to handle the currents to the meter. In the shunt circuits use wire corresponding to the current to be measured. Use no less than #18 wire in any case. Second, be sure that the wire is mechanically connected to the lugs well enough to carry the current without solder, then solder perfectly taking every precaution to avoid rosin joints. This applies particularly to the shunts, for if a shunt opens up, the meter will be lost unless the circuit is fused. Third, take care to



**T**HE small Isolantite\* stand-off insulator really has no need of fatherly advice from the big coil form. Isolantite insulators cannot steal power from high-frequency circuits, for their extremely low loss factor keeps their power absorption at a minimum. In every part of a radio circuit, Isolantite ceramic insulation is a safeguard of efficient operation.

High mechanical strength of Isolantite is another important factor in limiting power losses. Comparatively small cross-sections withstand heavy loading, permitting the use of a small volume of dielectric without danger of mechanical failure.

High-temperature firing gives a non-absorbent body which resists the effects of moisture. Isolantite insulators

retain low power factors even when wet. Smooth, glazed surfaces readily shed dust and dirt, avoiding risk of flash-over in exposed locations.

Isolantite is manufactured in many standard forms for most radio applications. Cooperation in the formulation of special designs for new applications is an important aspect of Isolantite's service to its customers.

\*Registered Trade-name for the products of Isolantite, Inc.

# ISOLANTITE INC.

**CERAMIC INSULATORS**

Factory: Belleville, N. J. • Sales Office: 233 Broadway, New York, N. Y.

"When a very low signal is heard and it is spread over the band you will usually find that the first detector-oscillator cathode bias resistor has greatly increased in resistance putting 50 volts instead of 14 volts on the grid."

"If very weak on low frequency end of dial . . . look for 5 meg. grid leak changing value to about 3,000 ohms after five minutes of playing."

"If distortion is evident after warming up, check the plate coupling resistor (150,000 ohm) for changes in value."

"No pep or intermittent reception in these models has been traced to an open 1 megohm resistor in the detector screen circuit."

## HERE'S THE *Proof*..

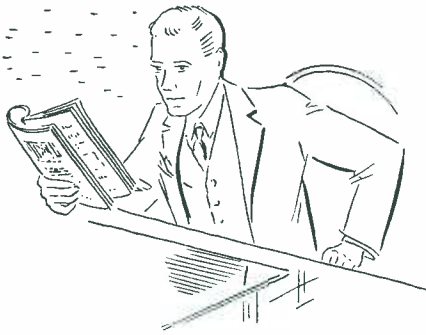

*It is cheaper*  
**TO BUY THE BEST!**

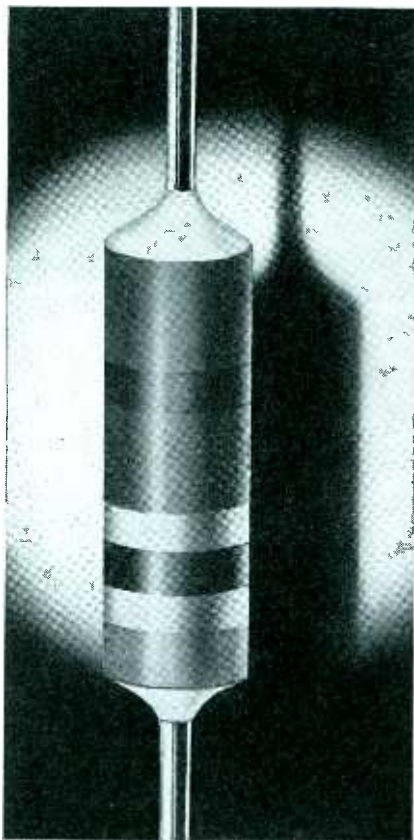

# ERIE INSULATED RESISTORS

Glance through the "Hints & Kinks" section of any popular service man's magazine and you will read a story of repeated operating failures caused by poor resistors.

Changes in value, shorting, and open circuiting, that mean extra expense for the owner and loss of confidence in the manufacturer are the results of using inferior resistors.

Erie Resistors show exceedingly small changes from their nominal resistance values under all types of ordinary operating conditions. We ask that you check this statement of quality and see for yourself how they stand up in your own equipment. A generous supply of either insulated or non-insulated resistors for test purposes will be sent to you on request.

**ERIE RESISTOR CORPORATION, Erie, Pa.**  
TORONTO, CANADA • LONDON, ENGLAND • PARIS, FRANCE-J.E.CANETTI CO.

RESISTORS • SUPPRESSORS • CERAMICONS • INJECTION MOLDED PLASTICS

determine that the two contact arms cannot be shorted together any place but at the points of contact on the switch, as shown. Fourth: The switch must have a detent to insure that measurements are not made on two shunts at once.

On meters to be used in high frequency work, the reactance of the bus wiring becomes of importance. The two gang switch in Fig. 4, is most desirable for this purpose since the bus wiring is the shortest possible, it be merely necessary to bridge the wires straight across between gangs, about a

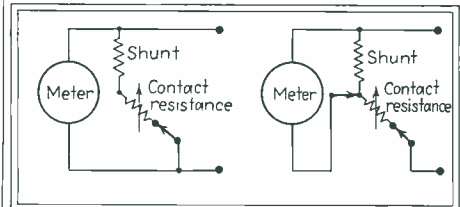

Fig. 6—Effect of contact resistance

half inch, and in some types of switch the lugs can be bent together and soldered. For particular work, however, a special switch may be advisable. Fig. 5, shows how such a switch may be built. Switches in Fig. 4 are readily available on the market.

Fig. 6 illustrates the subject of contact resistance. In the circuit at the left with a 5.2 ohm ammeter, the resistance of the shunt on the 100-times range would be on the order of 0.0525 ohm. With the best contacts likely to be used in such a circuit, the resistance would be on the order of 0.002 ohm. Since this is effectively in series with the shunt, a variation of contact resistance by this amount would therefore cause a variation of the meter reading on the order of 0.4 amp. in 10. If ordinary type range switches were to be used, the variation might easily be great enough to cause the burnout of the meter. In the circuit at the right the resistance is in series with the external circuit, and so variations have no effect on the meter reading.

### CHECKING PROPAGANDA



These receivers, installed in old fortifications near Paris, are tuned to stations in foreign countries. About 300 stenographers who speak several languages are employed by the French government to take down all announcements and speeches, to check propagandist activities

# CENTRALAB *Ceramic Capacitor*

CERAMIC DIELECTRIC FOR LOW POWER FACTOR. COMPOSITION ALLOWS COMPLETE CONTROL OF CAPACITANCE-TEMPERATURE COEFFICIENT

HEAVY COPPER COATINGS MAKE TUBULAR CAPACITOR PLATES

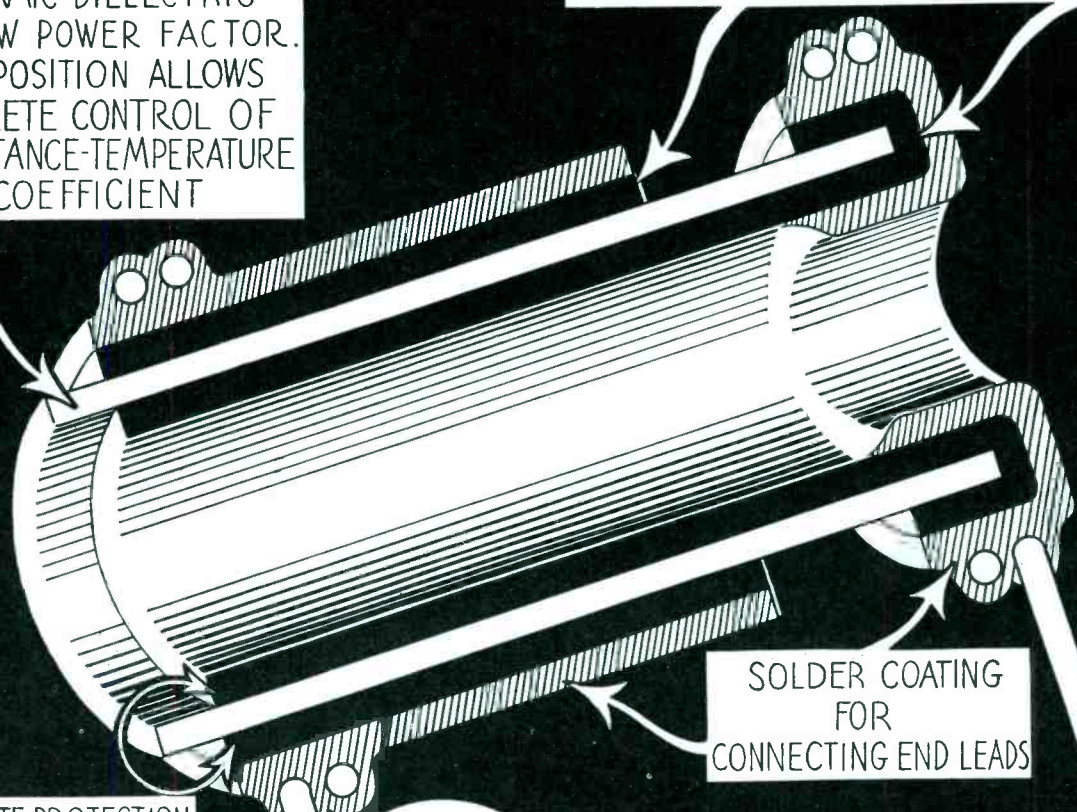

SOLDER COATING FOR CONNECTING END LEADS

ADEQUATE PROTECTION AGAINST BREAKDOWN AT 1000 Volts

CROSS SECTION OF A CERAMIC CAPACITOR

Introducing another member of the Centralab family

with the following characteristics and advantages:

● A single capacitor will provide any desired capacitance-temperature coefficient from 0 to a negative coefficient of .0007 mmfd. per mmfd. per degree centigrade.

- Ceramic dielectric has zero porosity. Capacity and power factor unaffected by aging or humidity.
- Low mass allows capacitor temperature to follow the chassis temperature closely.
- Capacitance remains constant at any frequency.
- Low power factor resin coating prevents moisture bridging between capacitor plates.

Manufacturers and set builders are invited to write our engineering department for more detailed data.

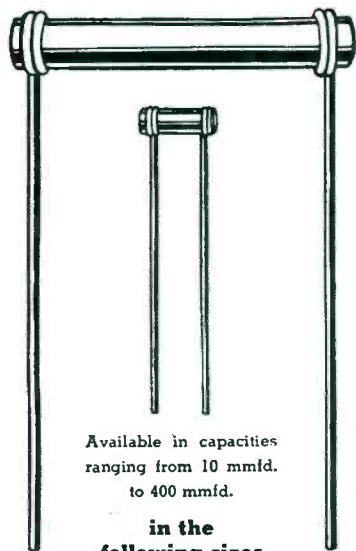

Available in capacities ranging from 10 mmfd. to 400 mmfd.

in the following sizes

- Type 816— $\frac{1}{4}$  x  $1\frac{3}{4}$  inch
- Type 814 —  $\frac{1}{4}$  x 1 inch
- Type 810— $\frac{1}{8}$  x  $\frac{3}{4}$  inch
- Type 813— $\frac{1}{8}$  x  $\frac{3}{8}$  inch



Division of GLOBE-UNION INC., Milwaukee

# "PINCOR"

## SILVER BAND DYNAMOTORS



Now... Choose the Unit that Fits the Job ...

★ "PINCOR" offers the only complete line of "B" power supply equipment for police units, air craft and radio broadcast service and sound systems. Available in a wide range of frames, sizes and capacities to fit any particular requirement.

★ "PINCOR" dynamotors are the last word in efficiency and regulation. Deliver high voltage current for proper operation of your apparatus with a minimum of A.C. ripple. These units will give years of smooth, quiet, satisfactory service. They are compact, light weight. Available with or without filter.

### NEW CATALOGUE FREE

Send for the latest "PINCOR" dynamotor catalogue which includes description of the new types "PS," "CS," and "TS" dynamotors. Mail coupon below.

### PIONEER GEN-E-MOTOR CORPORATION

466 W. SUPERIOR ST., CHICAGO, ILL.  
Export Address: 25 Warren St., N. Y., N. Y.  
Cable: Simonrice



Send for FREE Copy

PIONEER GEN-E-MOTOR CORPORATION  
Dept. R-4D, 466 W. Superior Street, Chicago, Illinois  
Please send me "Pincor" Silver Band Dynamotor Catalogue.

Name .....

Address .....

City..... State.....

# THE ELECTRON ART

Each month the world's technical literature is scanned to see what physicists and engineers are doing with tubes, for presentation in tabloid form to *Electronics'* readers

## Electronic Arc Length Monitor

AN INSTRUMENT for determining the voltage used in d-c arc welding is described by Walter Richter in the March issue of *Electrical Engineering* under the title, "An Electronic Arc Length Monitor". The device is an improvement over the voltmeter for d-c arc welding described in the March 1935 issue of *Electronics* in that it indicates deviations from some established arc voltage directly to the welder without requiring that he look away from the arc. The device may be considered as a null type of instrument in which two lamps are used to indicate deviations from normal arc voltage. When the arc voltage is established at the desired value, both lamps are extinguished. If the voltage rises above the established value, one of the lamps becomes incandescent, while the other lamp lights up if the voltage falls below the value for which the monitor is set.

Except for the rectifier, which is of the conventional type, the wiring diagram of the complete unit is shown in the accompanying schematic circuit.

The arc voltage is applied to two terminals at the left. A portion of this arc voltage is obtained from the opposing voltage drop across OM, obtained from the 300 volt source. For purposes of maintaining the voltage as nearly constant as possible, a voltage regulator tube is placed across  $R_4$  and  $R_5$ . The differential voltage is fed through a smoothing filter,  $R_{11}C_{11}$ , so that the mean value of the difference voltage becomes the grid bias for the 6J7 amplifier tube.

An alternating voltage, whose magnitude depends upon the grid bias voltage of the 6J7, is produced by applying a small alternating voltage to the grid of the first amplifying tube and varying the amount of amplification by changing the d-c grid bias voltage. The amplified alternating voltage appearing in the output of the first tube is connected in series with a fixed alternating voltage of opposite phase. The sum of these two alternating voltages is a new alternating voltage which changes its phase as well as its magnitude. This new alternating voltage is fed into the primary winding of a transformer, the secondary of which is center-tapped,

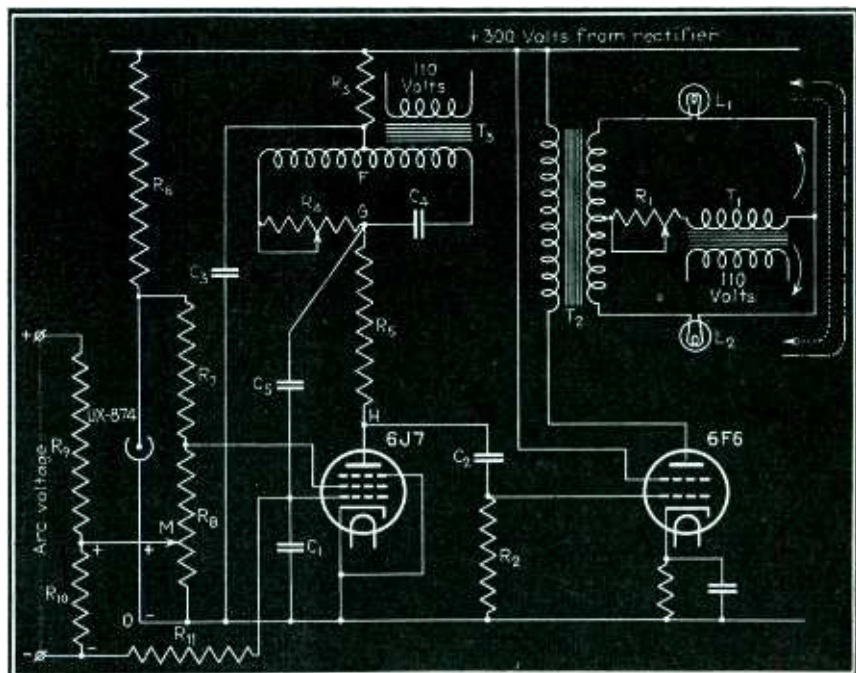

Schematic wiring diagram for electronic arc-welding voltage determining device



*Low  
Cost*

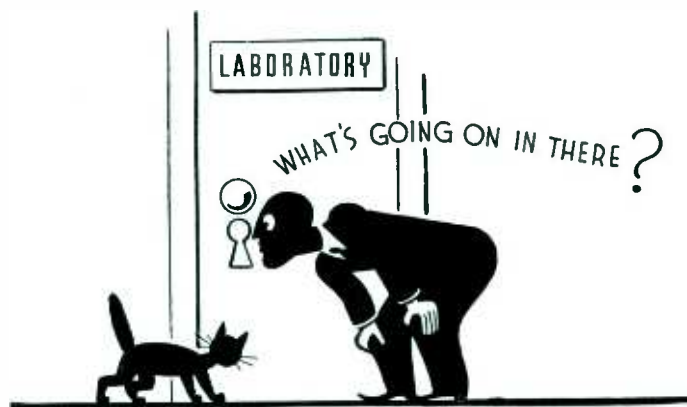

# MARKET RESEARCH

Are you barred, by the thought of prohibitive expense, from having a research job done in the hundreds of laboratories and engineering quarters where inventions and designs for man's industry and recreation are being fashioned into things which will soon emerge as quantity-production items?

Behind these doors of engineering, which often are closed to the salesman and his samples, are the men who are guiding the future of this amazing field of electronics and its allied industries. But, through every door of any account goes the *magazine* ELECTRONICS. That is more than penetration. In many cases it is exclusive entry.

One advertiser got a profitable order from a motor car builder—another from the paper industry—another from the shoe industry, as a

result of ELECTRONICS ADVERTISING. An instrument maker tells of receiving over 300 quality inquiries from an announcement of a new item. A specialized machinery maker says that he found ELECTRONICS to be a "bible" wherever he travelled in Europe. Another consistent advertiser says he used ELECTRONICS because it is impossible to cover the market by personal contact method. A maker of relays says, "One of the largest orders that came our way recently was due almost entirely to an ad placed in ELECTRONICS." A resistor maker says, "ELECTRONICS has obtained more live prospects per dollar than any other publication we have used." A seamless tubing company got one of their biggest customers from their first advertisement in ELECTRONICS.

*Those who use ELECTRONICS consistently for new-market search, find it to be one of the lowest-cost, highest-profit divisions in their sales departments. Ask us to show you the evidence.*

**ADD ELECTRONICS TO YOUR SALES ORGANIZATION**

ELECTRONICS — April 1938

49

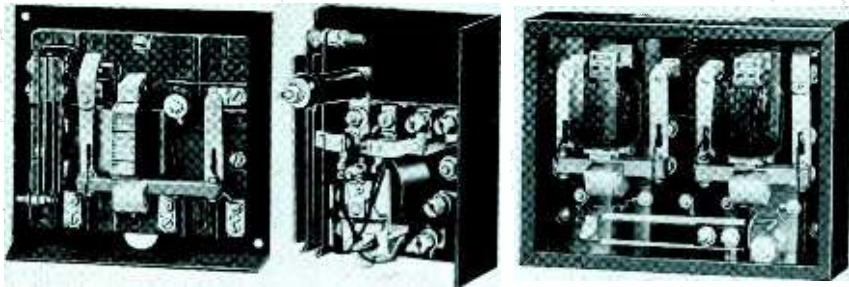

## THESE RELAYS



81



106



131

## SERVE ALL



132

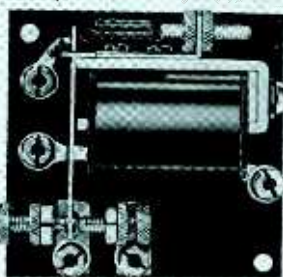

251

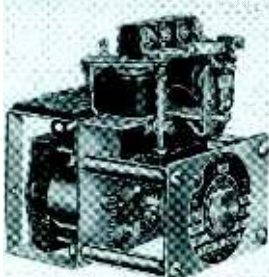

362

## REMOTE CONTROLS

Probably the greatest advance in design of electrical control equipment has come in the field of relays. Ward Leonard has pioneered this work giving relays that are more desirable, more positive, more sensitive and at the same time that operate with less electrical loss.

Send for copies of Relay Bulletins to bring your data files up to date on these new and improved relays for your every purpose.



# WARD LEONARD ELECTRIC COMPANY

*Electric Control Devices Since 1892*

Ward Leonard Electric Company, 32 South Street, Mount Vernon, N. Y.

Please send me folder containing a full set of your latest relay bulletins.

Name .....  
 Firm .....  
 Address .....  
 City and State .....

through a second amplifying tube, 6F6. The two sections of the secondary winding and the bulbs  $L_1$  and  $L_2$ , form a bridge arrangement. Between the center tap of the transformer and the junction of the lamps, a fixed alternating voltage is introduced. The current produced by this fixed voltage is adjusted to a valve just below that required for the lamps to glow. Grid excitation of the 6F6 amplifier will produce currents in the bridge circuit in the direction of the arrows, depending upon the phase of the excitation voltage. A voltage induced in the secondary winding of the center-tapped transformer will then increase the current in one lamp and decrease it in the other, depending upon the phase of the induced voltage actuating the grid of the 6F6 tube.

### Secondary Emission in Amplifying Tubes

THE PRINCIPLE of amplifying electron currents by means of secondary emission, and the application of this principle in conjunction with photo-electric tubes is discussed by J. L. H. Jonker and A. J. M. v. Overbeck in the March issue of *The Wireless Engineer*. The article describes a construction and gives characteristics of an amplifying tube having an indirectly heated cathode, in which the amplification is effected by secondary emission, and in which the electrons are subjected to electrostatic deflection before reaching an auxiliary cathode.

### Air Purification by Electrical Means

A METHOD of air purification developed by engineers of the Westinghouse Electric and Mfg. Co., which removes practically all of the dust, dirt, smoke, and soot from the atmosphere passing through the purifier, uses electronic methods exclusively, and shows promise of opening up new fields for electronic applications in the construction of individual small homes as well as large apartments and business buildings.

Essentially the precipitating purifier depends upon the fact that particles of dirt become electrified in passing through an electric field, and may then be collected on a charged plate. In this respect the precipitator is similar to others which have been used for several years. In the Westinghouse system, however, the functions of ionization and precipitation are performed in two stages. In the first, the dust laden air is ionized by passing it through wires and plates having a high voltage gradient. The ionized air is then made to pass through parallel plates having a potential difference between them of 5,000 volts, the dirt being accumulated on either one of these plates. When the charged plates become dirty, they may be cleaned by turning off the voltage, and washing with the spray from a garden hose. It is claimed that the cost of operation is exceedingly nominal.



# DIRECTIONAL CONTROL



**Uni-Directional  
Bi-Directional  
Non-Directional  
response all  
in One unit!**

★  
**SHURE  
TRI-POLAR**  
Crystal  
Microphone

The performance of 3 microphones in one unit! With the three basic directional characteristics instantly available through a three-point selector switch, the Tri-Polar gives you true directional control, eliminates feedback and background noise. Model 720A "Tri-Polar," complete with 25 ft. cable, lists at..... **\$39.50**

For complete information, write for the Shure Technical Bulletin.



## New Directional Baffle

This new directional baffle for the popular 700A Crystal Microphone reduces pickup of high-frequency sound coming towards the back and sides—tends to reduce feedback and cut down background noise. Quickly attached or removed. Write for full details.

Model A90A Directional Baffle lists at..... **\$2.50**

Model 700A "Ultra" Wide-Range Crystal Microphone, complete with 7 ft. cable, lists at..... **\$25**

Shure Patents Pending. Licensed under patents of the Brush Development Company.



## Four Trace Oscilloscopes

TWO NEW TYPES of four trace oscilloscopes are described by Manfred von Ardenne in the December 1937 issue of *Archiv für Technisches Messen*. One of these oscilloscopes, consists essentially of two double trace tubes as described in the October 1936 issue of *Electronics*, and produces two pairs of oscilloscope traces on the screen, one pair from each two trace structure.

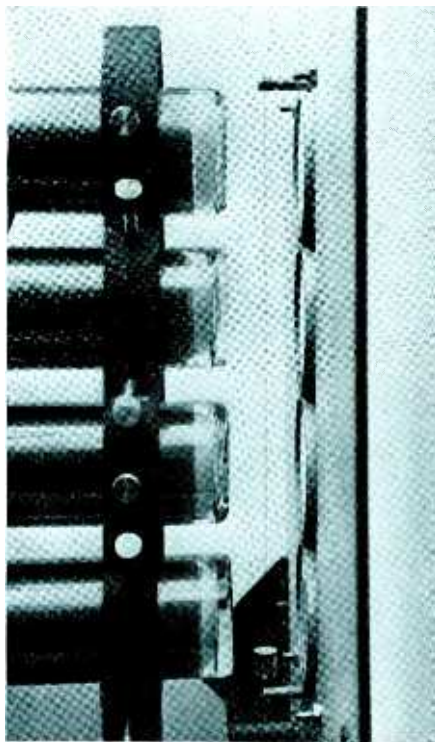

Close up of the screen ends of the four single trace cathode ray tubes which are used to produce four simultaneous traces. The screens of the individual tubes are viewed through the four lenses seen at the right. Set screws on the yoke holding the tubes may be loosened so that the tubes can be rotated for proper orientation. Vertical traces may be aligned by means of the thread between the lenses and the tube screens

The filaments, which operate at 4 volts, are connected in parallel within the tube, and all four tube structures are operated from a common anode supply with voltages up to 10,000 volts. Separate terminals are provided for each of the eight vertical deflectors as well as for the horizontal timing traces.

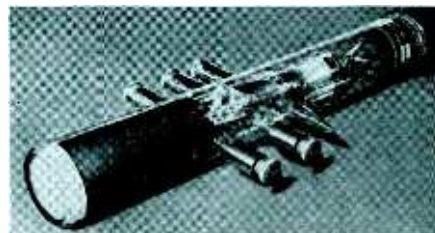

Single trace cathode ray tube which is used in the four trace oscilloscope. The screens are 2 in. in diameter and are ground plane

# Here It Is!



## THE Instrument of 1000 Uses

Engineers and experimenters are very enthusiastic about this pocket size instrument, sturdy and precision built. Handy for laboratory, shop or field use.

**HANDY SIZE  
COMPLETE A.C.  
AND D.C.  
MOLDED CASE  
AND PANEL** **DEALER NET \$15.00**

## POCKET VOLT-OHM-MILLIAMMETER

Model 666—Has 3" Sq. Triplett Improved Rectifier Type Instrument.  
A.C.-D.C. Voltage Scales Read: 10-50-250-500-1000 at 1000 Ohms per volt.  
D.C. Milliampere Scale Reads: 1-10-50-250.  
Ohms Scales Read: Low 1/2-300; High 250,000.  
Size 3 1/16" x 5 7/8" x 2 1/8".  
Black Molded Case and Panel.  
Low Loss Selector Switch.  
Complete with Alligator Clips, Battery and Test Leads. **DEALER PRICE.....\$15.00**  
A complete instrument for all servicing and other needs. Can be used for all A.C.-D.C. voltage, current and resistance analyses. Resistance range can be increased by adding external batteries.  
Attractive Heavy Black Leather Carrying Case with Finished Edges and Strap, Model 669, supplied extra. **DEALER PRICE.....\$3.67**

WRITE FOR CATALOG



The Triplet Electrical Instrument Co.  
234 Harmon Dr., Bluffton, Ohio

Please send me more information on Model 666;

I am also interested in.....

Name.....

Address.....

City.....State.....

# Announcing the new PRESTO 16-X RECORDER



**A** COMPLETE, two speed, sixteen inch, high fidelity recorder and reproducer mounted in a single case . . . the recorder you have always wanted for your shortwave truck and remote pickups where size and convenience in handling are important.

### Specifications

- Size:** . . . . . Width, 21"—Depth, 24"—Height, 13½".
- Weight:** . . . . . 79 pounds.
- Turntable:** . . . . . Sixteen inch with two speed drive mechanism and PRESTO instantaneous speed change.
- Cutting Head:** . . . Presto 1-B high fidelity lateral magnetic head, range 50 to 6600 cycles, impedance 8 ohms.
- Pickup:** . . . . . Lateral magnetic, impedance 5000 ohms.
- Amplifier:** . . . . . Gain 115 db, power output 4 watts, response uniform within 2 db from 60 to 9000 cycles.
- Speaker:** . . . . . Eight inch, PM dynamic.
- Mounting Case:** . . Black leatherette finish.
- Microphone:** . . . . . Velocity with adjustable floor stand.

**Price \$560.00 F.O.B. N. Y.**

*A bulletin describing the Presto 16-X recorder will be sent at your request.*

**PRESTO** RECORDING CORPORATION  
143 West 19th Street, New York, N. Y.

The other four trace oscilloscope consists of four single trace cathode ray tubes, mounted one above the other. Since each tube has no internal connections with any other, strays and interactions are easy to eliminate. Furthermore, the fundamental idea may be used for any number of traces by the simple expedient of adding more tubes.

Orientation of the traces is accomplished by rotating the tubes, so that electrical circuit complications are avoided. Three sets of adjusting screws are provided near the front of the tube supports which permit the tubes to be rotated on their axis until the vertical traces of all four tubes are properly aligned.

### Cornstalk Acoustical Board

FOR SEVERAL YEARS the Engineering Experiment Station of the Iowa State College has been concerned with the utilization of industrial waste products. As might be expected from a college in the center of the corn belt, the waste products of corn have been given considerable attention in this program. Perhaps the outstanding development in the past few years in the utilization of agricultural wastes has probably been the development from them of insulating board. Although often confused with wallboard, insulating board is an entirely different product intended to supply the need for a structural material which is uniform in quality, low in price, and which has relatively high thermal insulating and sound absorbing properties.

The subject of utilization of agricultural wastes is treated at some length in the following publications from Iowa State College:

Corn-Stalks and Cobs in Industry, *Scientific Monthly*, May, 1929.

Cornstalks as an Industrial Raw Material, *Bulletin 93*, June, 1930.

Agricultural Wastes in Industry, *Jour. Chem. Ed.*, December, 1931.

Utilization of Agricultural Wastes and Surpluses, *Bulletin 113*, March, 1933.

Studies of the Manufacture of Insulating Board, *Bulletin 136*, August, 1937.

Cornstalk Acoustical Board, *Bulletin 137*, August, 1937.

The last publication is probably the most significant to those engaged in the electronics or related fields, and deals with fundamentals of sound and acoustic, apparatus and testing methods for making determinations on cornstalk acoustical board, the effect of composition, and surface treatment upon the coefficient of absorption, and the effects of various applications of this agricultural acoustical board.

When measured at 512 cycles per second, the absorption of cornstalk acoustical material is about 21% to 36%, depending upon the thickness of the solid board, the method of manu-

facture, and the surface treatment. The absorption may be increased by varying the paper content of cornstalk board, as well as by boring holes in the board. The absorption increases as the number of quarter inch holes per unit area is increased, reaching a maximum at about 225 holes per square foot, when the absorption coefficient is about 95% at 512 cycles.

Up to a certain point, depending upon the absorptiveness of the basic board and the size of grooves cut in it, the addition of grooves increases the sound absorption in proportion to the number of grooves added. Certain hollow types of cornstalk board were found to be acoustically more effective than the same amount of material in the form of solid sheets.

It is apparent that those in the electronics field must depend, at least in some small measure, upon the activities of the American farmer. This dependence is more real than is apparent at first glance. Maybe it is beside the point; perhaps we occasionally engage in idle day dreaming. But with alterations going on on the 30th floor where *Electronics* is edited, we were just wondering how much we might expect to collect from the government for not writing this story because the office is too noisy, because some farmer was paid a nice lump sum of money not to raise the corn which might be used to quiet the office so that this squib might be written.

### High Mu Tubes in Resistance Coupled Amplifiers

TRIODES having amplification factors of 70 to 100 are widely used in resistance coupled amplifiers. In such circuits, the voltage actually applied to the plate of the tube is likely to be in the vicinity of 50 to 150 volts, so that a grid bias of 1 to 1.5 volts is required. Such values of bias are of the same magnitude as the inherent positive grid bias exhibited by tubes. A grid bias sufficient to counteract the inherent grid bias and provide for the application of signal voltage often results in the use of a bias voltage so large as to affect the gain adversely.

In a study of this problem, engineers of the National Union Laboratories made measurements on a number of types of tubes under different circuit conditions. In the conventional circuit, the grid bias is obtained by a bias cell in series with a 1 megohm resistor. In the other circuit, the grid bias is provided by means of a 15 megohm grid resistor.

Tests on two hundred 6Q7G tubes and an equal number of 6B6G tubes indicate that high gain, greater uniformity of gain, and less distortion result for the circuit using the 15 megohm grid leak rather than for the 1 megohm leak in conjunction with the bias cell. The same conclusions hold when the heater is 8.0 volts as well as when it is 6.3 volts.

**do you know**  
that  
**CINAUDAGRAPH SPEAKERS**  
are now *competitively* priced?

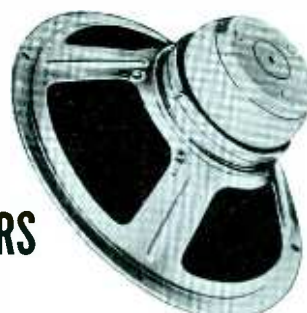

You're familiar with Cinaudagraph performance. You have heard all about the unusually high quality built into these modern electro-dynamic and permanent magnet speakers... quality that comes only from the closest engineering supervision, constant checking of raw materials, a rich background of specialized experience.

But do you know that Cinaudagraph speakers are now *competitively priced*—that the Cinaudagraph unit designed to fit your needs costs no more than the same type in an ordinary speaker? Cinaudagraph offers you today at no extra cost reproducers—famous for their power, simplified construction, and wide frequency.

Now available in a complete line of P. M.'s and electro-dynamics. Buy from a source of supply whose financial stability is beyond question. Buy Cinaudagraph! Complete details on request.

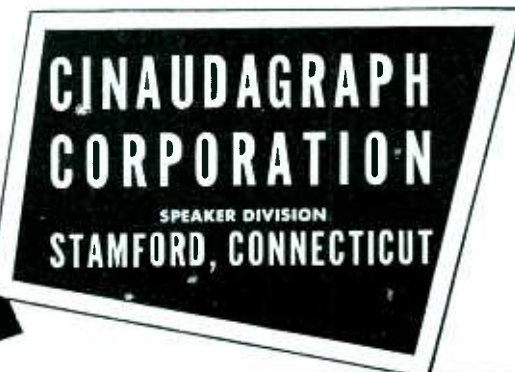

## BLILEY CRYSTALS



are manufactured for all frequencies from 20 Kc. to 30 Mc. Precision holders and ovens are available for standard and special applications. Bliley Broadcast Frequency Crystals are approved by the F.C.C.



**BLILEY ELECTRIC CO., ERIE, PENNA.**

## LEACH (LR) RELAYS

**ALWAYS ON THE JOB GIVING  
DEPENDABLE OPERATION**

The new Leach Impulse Relays make possible many new developments such as new circuits, new lock-out schemes—alarm systems and safety devices. Operation is dependable, absolutely quiet, and fast... time required to shift from one position to the other is approximately 1/60 second.

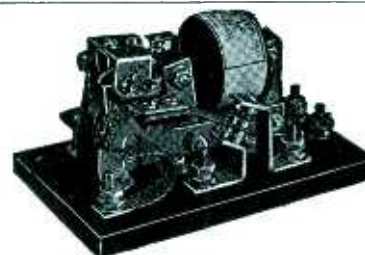

**LEACH RELAY COMPANY**  
5915 Avalon Boulevard, Los Angeles, Calif.  
15 E. 26th St., New York City

LEACH RELAY CO., 5915 AVALON BOULEVARD, LOS ANGELES, CALIF.  
Please send me your new catalog. I am interested in ..... relay.  
Name .....  
Company .....  
Address ..... City .....

# MANUFACTURING REVIEW

## News

◆ Lear Developments, Inc., announce the opening of a new office, laboratory, factory, and service shop at Roosevelt Field, Bldg., 31, Mineola, N. Y.

◆ The appointment of E. F. Carter as assistant chief engineer for Sylvania radio tubes has been announced by Sylvania Chief Engineer, R. M. Wise. Mr. Carter has been a member of the Sylvania Engineering Dept. since Sept., 1932, when he was appointed consulting engineer on tube application problems. In 1933 he was made division tube engineer for the Emporium, Pa., plant.

◆ Fully confident of an early business recovery from the depression which started last August, the Aerovox Corp., 70 Washington St., Brooklyn announces the leasing of additional floor space for further expansion of its plant and office facilities.

◆ For the purpose of manufacturing and distributing a new audio replacement vibrator called "Vibrapower," the Pauley-James Corp., of 4619 Ravenswood Ave., Chicago, has been founded.

◆ A report for the year ended December, 1937, showing a net profit over that for 1936 of approximately 36 per cent was announced by the International Nickel Company of Canada.

◆ According to the annual report to stockholders for the year ending December 31, 1937, the Western Electric Co.'s volume of business in 1937 showed a marked improvement over 1936. Sales for the year increased 39 per cent, payrolls 61 per cent, and profits 4 per cent over 1936, notwithstanding a substantial reversal in trend of business during the latter part of the year due to a nation wide depression. Sales totalled \$203,467,000 in 1937 as compared with \$146,421,000 for the previous year.

◆ Dr. Joseph Slepian becomes Associate Director of Westinghouse Elec. & Mfg. Company's Research Div., after 21 years of service with that company. Dr. Slepian is the inventor of a lightning arrester using thin carborundum



and clay discs in a porcelain container—also supervised the development of a de-ion circuit breaker. He has made numerous contributions to electrical engineering literature.

◆ The 18th annual report of the Radio Corp. of America for the year ended December 31, 1937, shows a total gross income for RCA of \$112,639,498 in 1937, compared with \$101,186,310 in 1936. This represents an increase of 11.3 per cent for the year due to increase in business during the first three quarters of the year. The consolidated net profit of RCA amounted to \$9,024,858 for 1937, representing an increase of 46.6 per cent over 1936 figure of \$2,868,921.

◆ Total operating revenues of the Bell System in 1937 were \$1,051,400,000, an increase of \$56,500,000 or 5.7 per cent over the previous year according to the report of the directors of the American Telephone & Telegraph Co. More than two-thirds of the \$69,000,000 increase in expenses was due to increased taxes and higher wage rates.

**★ ★ ★ TRUST A SPECIALIST!**

Best results, always, from specialized experience. And 35 years' concentration on Spring and Stamping problems amply qualifies HUNTER to work with you. We can design it... make it... assemble it. Two plants with most modern equipment always at your service. (Inspection of new plant, just opened, cordially invited). Literature upon request.

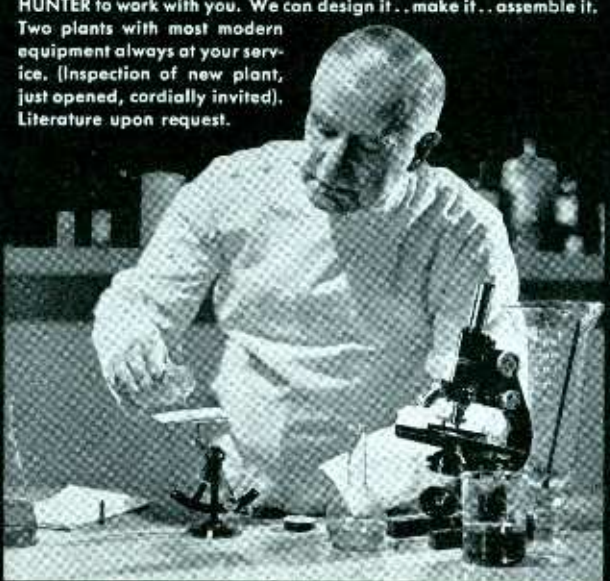

**HUNTER PRESSED STEEL COMPANY**  
LANSDALE, PENNSYLVANIA

## Literature

Manufacturers' literature constitutes a useful source of information. Readers who wish copies of items listed below may obtain them by contacting the manufacturers.

**Power Tubes.** Descriptive table giving informative data on various types of power tubes is contained in a four-page leaflet recently issued by Collins Radio Co., Cedar Rapids, Ia.

**Signal Generator.** An illustrated 4-page folder showing the characteristics and construction of a standard signal generator having a frequency range of from 9.5 kc. to 30 Mc. is available from the General Radio Co., Cambridge, Mass. The output is continuously adjustable from 0.5 microvolts to .01 volt.

**Television Parts.** A folder describing new television parts and giving wiring diagrams is available from the Parts Division, Radio Corporation of America, Camden, N. J.

**Vacuum Thermocouple.** Bulletin E, describing some of the applications for, and containing a list of vacuum thermocouples, is available from American Electrical Sales Co., Inc., 65 East 8 St., New York.

**Relays, Timers, and Thermostats.** These products are all thoroughly treated in the new technical catalog just issued by Struthers-Dunn, Inc., 139 N. Juniper St., Philadelphia, Pa.

**Explosion Protection.** An electron tube device designed to shut off gas and prevent explosion in case of flame failure, is described in Bulletin 1102 which may be obtained from the Wheelco Instrument Co., 1929 So. Halsted St., Chicago.

**Screw Products.** A 4-page folder, "Third Hand Information" outlines the advantages of the Phillips recessed head manufactured by the American Screw Co., Providence, R. I.

**Self-Locking Fasteners.** For aircraft purposes, self-locking fasteners are described in Catalog C issued by Dzus Fastener Co., Inc., Babylon, N. Y.

**Testing Plastics.** A bulletin, No. 20584, on the testing of finished pieces of plastic and moulded insulating materials for physical properties, is available from Testing Machines, Inc., 468 West 34 St., New York.

**Laminated Sheets.** A 48-page, illustrated booklet, "Bakelite Laminated," discussing the physical, electrical and mechanical properties of laminated sheets, tubes, and rods is a new catalog by Bakelite Corp., 247 Park Ave., New York.

# Complete New Line of Low Cost Plate-Filament Transformers

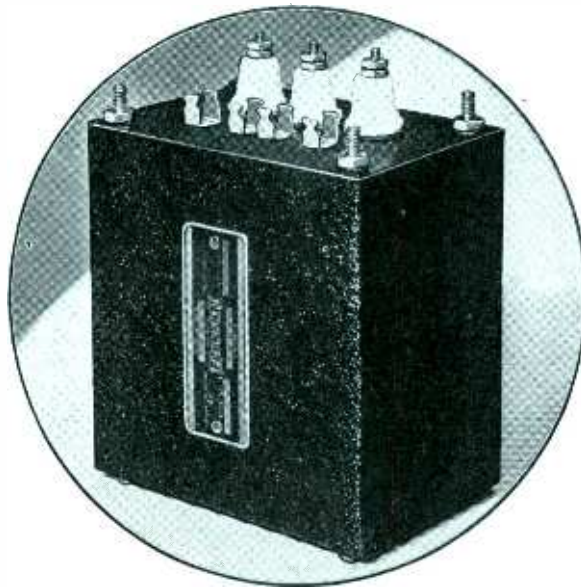

## ● Built to the Ferranti Standard of Quality!

Standard units for All Low and Medium Power Applications.

Suitable for use with All the Latest Tubes.

- High Efficiency.
- Low Regulation.

Low Temperature Rise coupled with High Insulation.  
Fully impregnated to withstand severe Climatic Conditions.

- Heavy Duty Type.

Well Known Ferranti through type Reversible Mounting.

Write for complete descriptive literature.

*Ferranti Electric Inc.*  
R. C. A. BUILDING, NEW YORK, N. Y.

# S.S. White **MOLDED RESISTORS** *The "All-Weather" Resistors*

## AMONG THE USERS

Radio Corporation of America  
RCA Manufacturing Co., Inc.  
RCA Communications, Inc.  
General Electric Co.  
Westinghouse Elec. & Mfg. Co.  
Automatic Electric Co., Ltd.  
Bartol Research Foundation,  
Franklin Institute  
R. S. Hart — Moisture Gauge  
Merck Institute of Therapeutic  
Research  
National Technical Laboratories  
Roller-Smith Company  
General Talking Pictures Corp.  
National Broadcasting Co.  
Pan American Airways, Inc.  
Railway & Industrial Engineering Co.  
Webster Electric Co.  
Audio Research, Inc.  
U. S. Army and Navy  
Griffith Observatory

**... 1,000 OHMS TO  
1,000,000 MEGOHMS**

Full details and illustrations in  
**RESISTOR BULLETIN 37**

Free copy with Price List sent  
on request. WRITE for it.

## NOISE TESTED

At slight additional cost, resistors will  
be supplied individually "noise-tested"  
to this specification: "For the complete  
audio frequency range, resistors shall  
have less noise than corresponds to 1  
part in 1,000,000." (For values up to  
10 megohms)

# S. S. WHITE

The S. S. White Dental Mfg. Co.

**INDUSTRIAL DIVISION**

10 East 40th Street, Room 2310E, New York, N. Y.



## Frequency Measuring Service

Many stations find this exact measuring service of great value for routine observation of transmitter performance and for accurately calibrating their own monitors.

**MEASUREMENTS WHEN YOU NEED THEM MOST**  
*at any hour every day in the year*

**R.C.A. COMMUNICATIONS, Inc.**

*Commercial Dept.*

A RADIO CORPORATION OF AMERICA SERVICE

66 BROAD STREET

NEW YORK, N. Y.



## WAXES • COMPOUNDS • VARNISHES for ELECTRICAL INSULATION

Zophar offers prompt service on Insulating Compounds for a wide variety of electrical applications, including:

Insulation for CONDENSERS, TRANSFORMERS, COILS, power packs, pot heads, sockets, wiring devices, wet and dry batteries, etc. Also WAX SATURATORS for braided wire and tape. WAXES for radio parts.

Special compounds made to your order.

# ZOPHAR MILLS INC.

130-26th St.

Brooklyn, N. Y.

FOUNDED 1846

**Instrument Bulletin.** A publication devoted to extending the benefits of electric instruments is a new house organ entitled "Instruments in Industry" which will be issued periodically by the Meter Division, General Electric Co., Schenectady, N. Y.

**Springs and Wire Forms.** A new booklet on designing and production facilities for springs of all kinds is offered by the Hunter Pressed Steel Co., Lansdale, Pa.

**Monel Strip.** A new price list covering Monel and "A" nickel strip has recently been released by the Somers Brass Co., 350 Madison Ave., New York City.

**Cone and Voice Coil Assemblies.** A two-page speaker bulletin giving instructions for installing cone and voice coil assemblies in Magnavox speakers is available from the Magnavox Co., Fort Wayne, Ind. Also available is a two-page leaflet describing high capacity a-c and d-c receiver supply filter.

**Velocity Microphone.** Instructive information on a velocity type microphone requiring no polarizing voltage but generating its own signal voltage is available in a single page brochure issued by the Bruno Laboratories, 30 West 15th St., New York.

## New Products

### Tube Developments

NEW TUBES announced by the RCA Manufacturing Co., Harrison, N. J., for this month include the type 1851 television amplifier pentode. The RCA-1851 is a heater-cathode type, metal tube intended for use in experimental television receivers, especially in the radio frequency and intermediate frequency stages. Heater voltage is 6.3 volts, with a current of 0.45 amperes.



Maximum plate voltage is 300, screen voltage 150 volts maximum. Plate resistance is 0.75 megohm, plate current is 10 milliamperes, and the screen current is 2.5 milliamperes. An advantage of this pentode is its high transconductance of 9,000 micromhos. The tube uses the standard octal base but the control grid cap is considerably smaller than usual.

A triple grid super-controlled amplifier, 6S7 is a pentode tube in metal envelope intended for high frequency stages of radio receivers designed for low heater power consumption. The heater operates at 6.3 volts and 0.15 amperes. Maximum plate voltage is 250; screen voltage is 100 volts maximum. Plate resistance is 1 megohm and the transconductance is in the vicinity of 1,500 micromhos, the actual value depending upon the electrode voltages.

### Resin Adhesive

A NEW PHENOLIC resin adhesive, No. 5116, is announced by the General Plastics, Inc., North Tonawanda, N. Y. Used as a coating it is capable of withstanding a 50% caustic soda solution and retaining its bond strength up to 100°. Softening point is between 115° and 120°.

### Amplifier Multi-Stage Inverse Feed-Back

A 25 WATT amplifier having frequency characteristic to within plus or minus



1½ db from 50 to 10,000 cycles and using multi-stage degeneration was announced by the Webster Co., Chicago. It has 2½ per cent distortion at 25 watts output.

### Compact Velocity Mike

A SMALL velocity microphone complete with output transformer, cable connector and switch has been announced by the Amperite Co., 561 Broadway, New York. It has an output of -70 db and a frequency response flat within 2 db from 60 to 7,500 cycles, and is obtainable in either low impedance (Model ACL) or high impedance (Model ACH).

## APPROVED FOR 1939 MODELS



### THE NEW IMPROVED 1100 SERIES GOAT FORM FITTING TUBE SHIELD

### Featuring

STURDY CONSTRUCTION  
GREATER STABILITY  
IMPROVED GROUNDING  
COMPLETE SHIELDING  
BETTER APPEARANCE  
MAGNETIC SHIELDING  
EASY ASSEMBLY  
SPACE SAVING  
BEADED TOP  
ECONOMY

ANNOUNCED last month, this new tube shield is quickly being written into the specifications for 1939 radio receivers in the process of design. Radio engineers recognized in this new shield ANOTHER step forward in Goat design.

The improvements represent the combined suggestions and co-operation of present users of Goat Tube Shields.

Write for samples and details.

## GOAT RADIO TUBE PARTS, INC.

314 DEAN ST., BROOKLYN, N. Y.

(A DIVISION OF THE FRED GOAT CO., EST. 1893)

**Proud of Your Product?**

Then "sign" it with an embossed nameplate that tells the world so! American Emblem Company nameplates carry the trademark of nationally-known manufacturers into the homes of millions. Every A E nameplate is an exclusive product. We carry no stock designs. Our designing service is at your disposal without charge. For quotations indicate quantity requirement. Write us today.

**AMERICAN EMBLEM CO.**  
Incorporated  
P. O. Box 116L Utica, New York

Sales Offices: New York, Chicago  
Philadelphia, Detroit, Dayton  
Representatives in all major cities.

**CALLITE**  
*Certified*  
**LEAD-IN WIRES**  
FOR HARD GLASS STEM

**C**ALLITE Certified lead-in wires of Tungsten, Molybdenum and Kulgrid have uniform, tested, proven quality—essential requirements for the production of radio and power tubes, lamps and neon signs.

**TUNGSTEN** . . Ground finish-free from longitudinal and other surface cracks—controlled crystal structure—excellent sealing quality.

**KULGRID "C"** . . Strands once welded stay welded and always remain flexible—does not oxidize or flake under high temperatures—high conductivity—eliminates shrinkage and rejection due to overoxidized and brittle copper strand.

**MOLYBDENUM** . . Ductile and easily shaped—high tensile strength—great rigidity.

*ANY combination and size of Kulgrid, Tungsten or Molybdenum can be supplied to your specifications in cut pieces or finished welds.*

**CALLITE PRODUCTS DIVISION**  
EISLER ELECTRIC CORPORATION  
544-39th STREET UNION CITY, N. J.

**Voltage Regulation**

A **VOLTAGE REGULATOR** which stabilizes an a-c voltage that may be varying from 95 to 130 volts and holds it constant at 115 volts plus or minus 1% automatically and instantaneously was recently announced by the Raytheon Mfg. Co., 190 Willow Street, Waltham, Mass. It is a magnetic device without moving parts or adjustments and will operate from any commercial a-c power source. It delivers one or more required voltages with power outputs up to several thousand voltamperes.

**Television Transformers**

**THREE TRANSFORMERS**, for use with the new kinescope television tube have been announced by the Thordarson Electric Manufacturing Co., 500 West Huron St., Chicago. One of these is a 2½ volt, 2.1 amp. transformer for the heater. One transformer delivers 3,000 volts or 2,000 volts at 3 milliamperes as well as filament voltage. The third transformer delivers 3,000, 4,500, or 6,000 volts at 5 milliamperes, in addition to the filament power.

**Sensitive Panel Instrument**

A **NEW LINE** of panel instrument with vertically disposed pivots is announced by the Sensitive Research Instrument Corp., 4545 Bronx Blvd., New York City. These new meters are available as voltmeters, milliammeters, or microammeters with as low as 1½ microamperes full scale deflection. The line also includes wattmeters with a full scale as low as 0.2 watts.

**Resistor Assembly**

**FOR THE CONTROL** of electrical apparatus where several circuits are to be varied simultaneously, a tandem construction and assembly of standard Ohmite units has been designed by engineers of the Ohmite Manufacturing Co., 4835 Flournoy St., Chicago. This as-

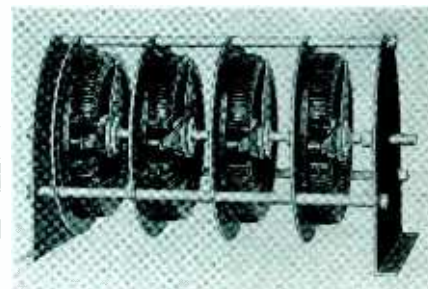

sembly can be supplied for two, three, four or more rheostats in tandem, using standard Ohmite rheostats. The same assembly can also be used with Ohmite tap switches. The assembly unit shown is 12 in. in diameter and contains four rheostats having a power rating of 1 kw. each.



## A-C Operated Oscillator

A TEST OSCILLATOR featuring precision control of frequency and output level has been introduced by the Weston Electrical Instrument Corp., Newark, N. J. Automatic amplitude control for any level from 1 microvolts to 0.1 volt may be obtained from the unit which operates from any 60 cycle, 110-120



volt line. Six individually calibrated, direct-reading frequency scales are provided covering the range from 50 kc. to 30 Mc. The frequency calibration is guaranteed accurate to  $\frac{1}{2}$  of 1 per cent except for the three shorter wave bands for which the precision is 1 per cent.

## Portable Potentiometer

SPECIALLY DESIGNED and built in three different models for use in field or laboratory service, a portable potentiometer, standardized with regulation standard cell, and equipped with precision slide wires and multipliers, is a new product of Wheelco Instruments Co., 1933 S. Halstead St., Chicago. A taut suspension galvanometer, complete with lock and zero adjuster is used. The units are obtainable with scales calibrated in millivolts or in degrees Fahrenheit or Centigrade, or both.

## Power Units

A D-C POWER SUPPLY delivering from 15 to 20 amperes, intermittent use, and with voltages from  $1\frac{1}{2}$  to 18 volts, is an-

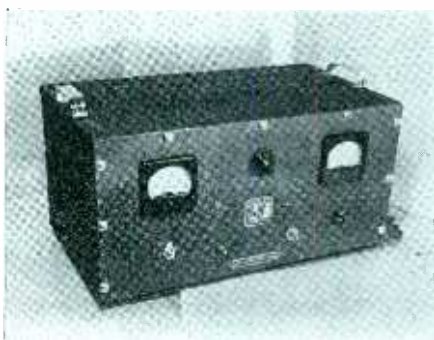

nounced by the B-L Electric Manufacturing Co., St. Louis, Mo. The unit uses a circuit in which the number of rectifier junctions is varied in accordance with the desired voltage.

# DuMONT

## ANNOUNCES A NEW LABORATORY OSCILLOGRAPH

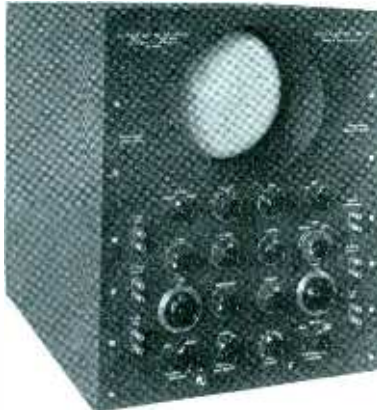

The Type 169 Nine Inch Laboratory Oscillograph was designed to meet the requirements of the research worker for a precision oscillograph of many applications. This new instrument incorporates many advanced and exclusive features of design.

### Features

- Du Mont Type 94-8-H nine inch Cathode Ray Tube with vastly improved uniformity of focus over entire screen area.
- High intensity of trace—3000 volt Cathode Ray Tube Power Supply permits studies with long persistence screens.
- Exclusive Du Mont single sweep circuit greatly aids the study of transient phenomena.
- Linear frequency response as low as 3 cycles per second.
- Push-pull symmetrical deflection of Cathode Ray Tube including Du Mont wave expanding feature.
- Linear sweep frequency range 3—30,000 cycles per second.
- Separate grid modulation amplifier allows simultaneous writing and timing of transients.
- Beam Switch greatly facilitates photography.
- Controlled return trace elimination.
- Convenient Direct connection to all four deflection plates.

Write For Complete Specifications

**ALLEN B. DU MONT LABORATORIES, INC.**  
UPPER MONTCLAIR      Cable Address:      NEW JERSEY  
WESPEXLIN, NEW YORK

# Made to do THIS JOB!



Silex Glass Coffee Maker  
The Silex Company  
Hartford, Conn.



**Wilco  
Highheat  
47**

- The Silex Company uses Wilco Highheat 47 in their "Anyheat Control" because of its greater strength and sensitive response to slight temperature changes.

Wilco engineers will recommend the correct Wilco Thermometal or electrical contact material for any condition of use. Send for "Wilco Blue Book of Thermometals."

The H. A. Wilson Company  
105 Chestnut St., Newark, N. J.  
Branch Office: 5 So. Wabash Ave., Chicago

# WILCO THERMOMETAL

(Thermostatic Bi-Metal)

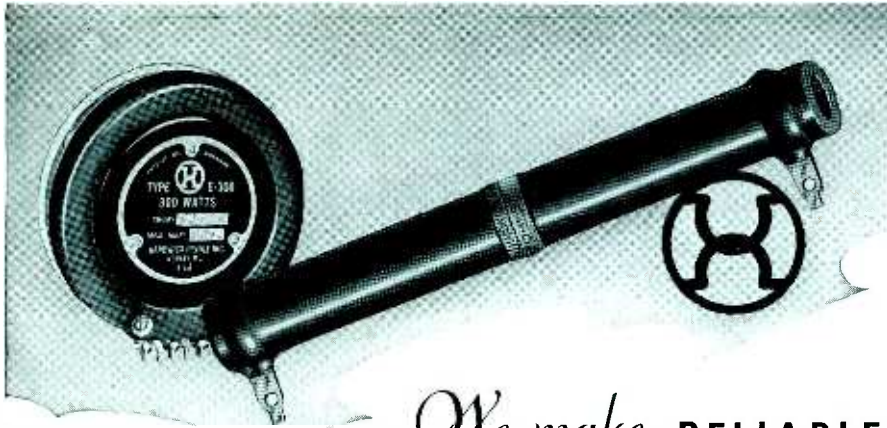

*We make* **RELIABLE RESISTORS AND RHEOSTATS FOR EVERY CONCEIVABLE REQUIREMENT**

For over 12 years we have specialized in this field.

In addition to our regular stock of fixed, tapped and adjustable vitreous enamel resistors and rheostats we maintain a diversified assortment of

component parts and fittings.

Our engineering cooperation is gladly offered to meet individual requirements quickly. Do not hesitate to call upon us for either resistor or rheostat service.

**HARDWICK, HINDLE • Inc.**  
136 PENNINGTON STREET — NEWARK, N. J.

**HIGH VACUUM PUMPS**  
OILS, GREASES and WAXES



**GAEDE AIR PUMPS** include a variety of Mercury Diffusion, Rotary Oil and Molecular Pumps with accessories, for producing and maintaining the highest possible degree of vacuum.

**LEYBOLD OIL DIFFUSION PUMPS** — using "Apiezon" Oil B — are now available for high vacuum work. No freezing traps required.

**"APIEZON" OILS, GREASES AND WAXES** have vapor pressures as low as  $10^{-10}$  mm. of Hg. at room temperature. They provide a non-poisonous liquid for Oil Diffusion Pumps and sealing media for high vacuum systems.

For full particulars, please write for Bulletin 1385-E.

**JAMES G. BIDDLE CO.**

ELECTRICAL INSTRUMENTS  
1211-13 ARCH STREET PHILADELPHIA, PA.



**A LEADER**  
*in Sound Reproduction*

Professionals and amateurs alike pronounce Astatic's new Model T-3 Crystal Microphone an outstanding leader in its field. Tilting head on unique swivel mount permits directional or non-directional position and controls acoustic feedback. Chrome finish. Complete with interchangeable plug and socket connector and cable.

Write for Literature  
LIST PRICE \$25.00



**Astatic Microphone Laboratory, Inc.**  
Dept. A-10, Youngstown, Ohio  
Licensed Under Brush Development Co. Patents

**Plug-in Condenser**

A NEW LINE of fixed capacitance, plug-in type condensers has been announced by the Allen G. Cardwell Manufacturing Corp., Brooklyn, N. Y. Plates are

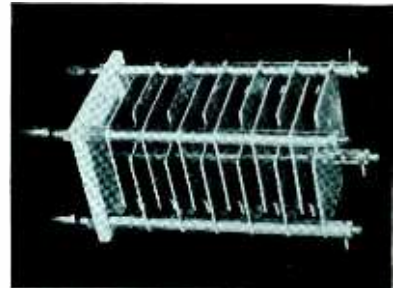

readily removable for fixed capacitance adjustment. The units are available in such ranges as to be especially suitable for circuits of amateur transmitters.

**Multiple Contact Relay**

MULTIPLE CONTACT direct-current relays in three types have been made available by the C. P. Clare & Co., 4541 Ravenswood Ave., Chicago, Ill. These units may be obtained for fast operation—fast release; delayed operation; or delay release.

**Gain Set**

A TRANSMISSION measuring set having a range of 99 db. is announced by the Cinema Engineering Co., 7606 Santa



Monica Blvd., Hollywood. The unit may be obtained in standard cabinet or standard relay rack mounting.

**Frequency Monitor**

TO ENABLE POLICE radio operators to check station frequency, a monitor having a frequency range of 1,500 to 3,000 kc and 30 to 42 megacycles, a frequency stability of plus or minus .02 per cent, and an audio output of 600 milliwatts has been introduced by the Radio Department of the General Electric Co., Schenectady, N. Y. It is a-c operated from the 110 volt, 60 cycle line.

## The TRANSITION POINT



AT JUST ONE POINT in the recording process is Sound transferred from the metal to the medium . . . where the Cutting Needle contacts the record. That is where precision counts. RECOTON Cutting Needles are precision-made of the finest quality tempered steel, highly polished for minimum scratch. Used for Acetate and Celluloid.

## RECOTON

CORPORATION  
178 Prince Street, New York

- For the past 15 years every major improvement in the electrical alloy art has been sponsored by Wilbur B. Driver.
- And in Tophet (pronounced tof-tet) you are offered the sum total of the pioneer's experience, skill and good name.

WILBUR B. DRIVER CO.  
NEWARK, NEW JERSEY

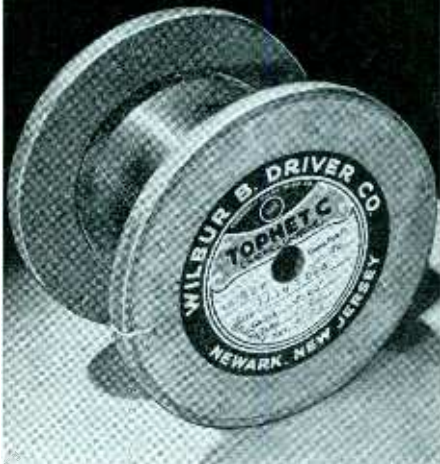

ELECTRONICS — April 1938

## Oscillograph Wobbulator

A NEW OSCILLOGRAPH wobbulator, Model 77-2 employing a 2 in. cathode ray tube has been announced by the Triumph Mfg. Co., Chicago. It employs a built-in 840 kc. frequency modulator automatically synchronized to the linear sweep circuit. Complete analysis of r-f and i-f circuits can be made by observing the resonance curve of each tuned circuit.

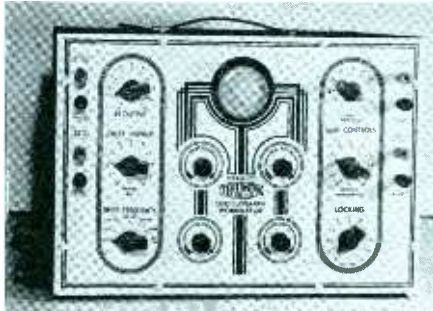

The oscillograph proper performs all the standard oscilloscope functions with a linear sweep of 10 to 45,000 cycles. A pattern-locking control assures stable patterns.

## Mica Condensers

A NEW CONDENSER, type BR, has been introduced by the Cornell-Dubilier Electric Corp., South Plainfield, N. J., to meet the rigid frequency requirements of push button tuning systems. The



condensers are encased in a low loss Bakelite, have a temperature coefficient of +0.003 per deg. C., are rated at 1,000 volts d-c, and may be obtained in capacitances from 10 to 1,100 micro-microfarads.

## Constant C Condenser

THE TYPE TB condensers introduced by the Solar Manufacturing Corp., 599 Broadway, New York, are intended for use with automatic frequency control receivers where the tendency to drift due to aging and temperature changes must be kept to a minimum. With these condensers a maximum to minimum capacitance range of 6 to 1 can be obtained. The condensers may be obtained with either a ceramic or a bakelite or supporting strip.

## Midget Volume Control

WITH VARIOUS interchangeable extensions a new line of volume controls was announced by the P. R. Mallory & Co., Inc., Indianapolis, Ind.

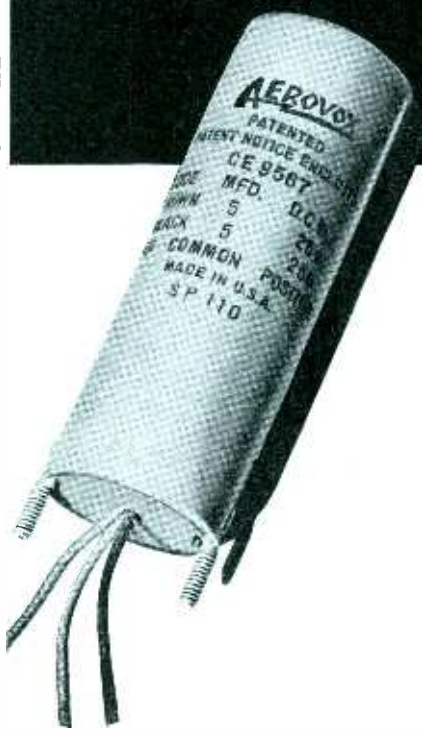
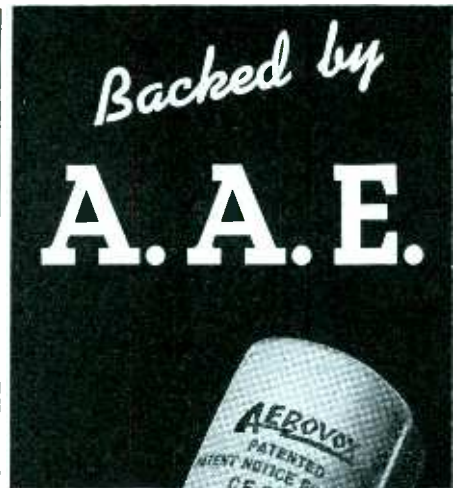

A.A.E.—AEROVOX APPLICATION ENGINEERING—costs you nothing. Yet in addition to insuring the RIGHT condenser for your job, it frequently means marked savings in other components for your assembly.

Case histories indicate tens of thousands of dollars saved by manufacturers large and small alike, through A.A.E.

So just submit that problem. Our engineers will provide genuine engineering collaboration, as well as the usual specifications, samples, quotations.



**WHAT'S YOUR  
RESISTANCE  
PROBLEM?**

Ohmite Engineers can help you work out an economical solution to your control - by - resistance problem. Write us today. No obligation.



**ORIGINATORS OF ALL-PORCELAIN  
VITREOUS-ENAMELED RHEOSTATS**

Each passing year further emphasizes the underlying sound design of OHMITE close-control rheostats. The all-porcelain, vitreous-enameled construction, and the use of copper-graphite brushes, which OHMITE pioneered on these small rheostats, has made it possible for innumerable electronic and electrical devices to remain in trouble-free service year after year. Today, in prominent broadcast, commercial and amateur transmitters and receivers, in test equipment and instruments, you'll find OHMITE resistance units doing the job right! Rheostats in single or tandem units with straight or tapered winding, in stock or special models to meet your specifications. 7 stock sizes from 25 watts to 1000 watts available for overnight shipment. Get your copy of OHMITE Catalog 16. Write for it now.

**OHMITE**

**RHEOSTATS  
RESISTORS  
TAP SWITCHES**

OHMITE MANUFACTURING CO., 4825 WEST FLOURNOY STREET, CHICAGO

**REMLER  
ATTENUATORS**

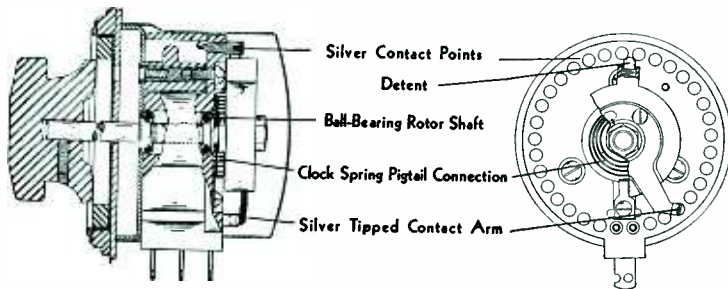

**BALL BEARING  
ROTOR SHAFT  
CLOCK SPRING  
PIGTAIL  
CONNECTION**

LA-5 Ladder  
Type—Net

**\$10.80**

New 1938 features. No increase in price! Improvements provide unequalled ease of operation and long life. Attenuation variable in 27 steps of 1 2/3 db. per step up to 45 db. fading in 3 additional increasing steps from 45 db. to infinity. A single sliding contact in the input circuit results in contact noise being attenuated within the unit in direct proportion to the loss introduced in the circuit, providing a constant signal-to-noise ratio. Impedance practically constant over entire range of the pad. Standard impedances of 50, 200, 250 and 500 ohms. Special values to order.

Remler Company, Ltd., 19th at Bryant, San Francisco

**REMLER—THE RADIO FIRM AS OLD AS RADIO**

**N. Y. City  
Radio System**

(Continued from Page 13)

or to a dynamic loudspeaker, or to the land-line input of the Headquarters transmitter (for two-way communication between fire boats), or to a remote Fire Department telephone instrument. In the latter position, a differential or hybrid coil eliminates audio feedback or "loop singing."

The Headquarters transmitter is of the modern broadcast type, installed in a penthouse on the roof of the Repair Shops in Queens. Nearby, on the roof, is the quarter-wave vertical insulated steel tower antenna, connected to the transmitter by a co-axial transmission line. The upper 22 feet of the vertical antenna is built to serve as a "J" receiving aerial. A tuned filter in the receiving co-axial line permits simultaneous use of the vertical antenna for transmission and reception. The Headquarters transmitter is operated unattended.

The remote pickup receivers were specified to conform to stability and selectivity standards which anticipated the recent action of the Federal Communications Commission in establishing relatively much closer channeling in placing the ultra-high frequency band on a commercial service basis. The pickup receivers are crystal controlled superheterodynes, and therefore relatively free of warming-up drift, need for frequent peaking or other attention. Vertical doublet receiving aeriels are used with co-axial connecting lines.

On eight of the nine fire boats steam turbo-generators furnish 120-volt, 60-cycle current for the radio installations. On the ninth fire boat, the "John J. Harvey," which is gasoline-electric driven, a motor-alternator is used. On each fire boat the control equipment and the superheterodyne receiver with its loudspeaker are in the pilot house. The fire boat transmitters are remotely controlled from the pilot houses, and connected by co-axial lines to vertical "J" antennas mounted high above the decks.

The system has been in operation for several months, and has furnished complete two-way coverage of the Port of New York.

April 1938 — ELECTRONICS

## Television Receivers

(Continued from page 31)

tor grid and to provide a satisfactory image response ratio.

This simple arrangement could be a single tuned circuit loaded with resistance to make its bandwidth sufficient. However, in practice a coupled circuit arrangement usually proves more satisfactory. The coupled circuit has the advantage of a much greater useful bandwidth for a given selectivity against undesired signals.

Capacitors may be used to tune this bandpass circuit. If the capacitors are variable so that the receiver can be tuned to the several television channels, the maximum capacitance must be large compared to the minimum capacitance plus stray circuit and tube capacitances. With a large capacitor the L/C ratio of the tuned circuit and consequently the circuit impedance becomes low. This in turn results in low overall gain, since the gain is essentially a function of the ratio of the input to output impedance of the system. These considerations point to the desirability of limiting the maximum capacitance of the tuning capacitor and consequently the tuning range of the receiver to as small a value as possible.

The tuning range in some experimental receivers covers the lower five television channels shown in Fig. 1, that is, about 44 to 90 Mc. The tuning capacitors then have a capacitance range of approximately 10 to 100  $\mu\text{mf}$ . Typical selectivity curves of such a tuner are shown in Fig. 6.

These curves show that the effective pass band of the tuner is nearly constant at all frequencies. If the tuner is adjusted so that the sound carrier frequently falls at one side of this response characteristic, and the picture carrier at the other side, then both carriers and the upper picture sideband will all be approximately uniformly passed. This uniformity of bandwidth over the tuning range is obtained by using principally conductive coupling between the two circuits. This conductive coupling occurs in the common impedance of the gang capacitor shaft and decreases with increasing frequency, since the current through the trimmer capacitors and circuit distributed capacitances does not flow

## RELAYS

FOR ANY INDUSTRIAL REQUIREMENT—

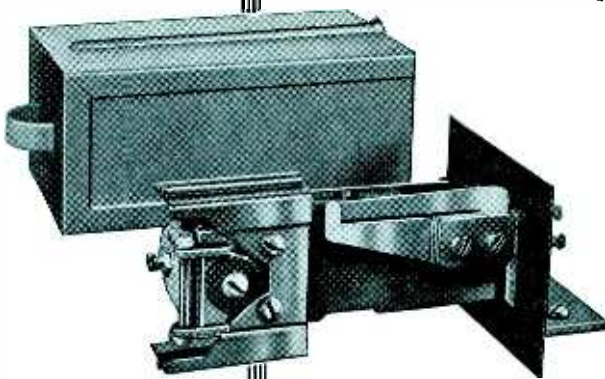

• Series AQA Relay equipped with Mounting Bracket, Cover Guide, and Cover. A standard model for general uses where requirements call for rapid switching of one or more circuits.

• The Automatic Electric line of relays includes quick and delayed action types, sensitive and heavy duty types, mechanical locking types, polarized relays, etc. Available with any contact combination and for operation on D.C. or A.C. circuits of any voltage.

Write for complete illustrated catalog of relays, stepping switches, electric counters, solenoids, keys, and other electrical control accessories. Address American Automatic Electric Sales Company, 1033 W. Van Buren St., Chicago.

**AUTOMATIC  ELECTRIC**

**CONTROL AND SIGNALING EQUIPMENT**

**One of many ALLIED Installations in well-known professional Recording Studios**



Four Allied Recorders in the studio of Sound Reproduction Corp., New York City.



For finest recording results, use Allied "CLEAN-CUT" Blanks.

Experience proved to this well-known studio that they can depend on Allied Recording Equipment to give them that degree of operating reliability so necessary to meet their high standard of recording results.

**ALLIED RECORDING PRODUCTS CO.**

126 W. 46th St., New York, N. Y.

Cable Address: Allirecord

**A NEW PRODUCT!**

**ANACONDA ELECTRO-DEPOSITED**

# Pure Copper Sheets

Stock widths 30" or 60" ... and in rolls of long lengths.  
 Thicknesses—1 ounce per square foot to 5 ounces per square foot (approximately .0015 inches to .007 inches).

**NON-POROUS ... RUST-PROOF**

Practical uses for Anaconda "Electro-Sheet" Copper in new fields are innumerable. *Samples upon request.*

**THE AMERICAN BRASS COMPANY**

Department "D4" Waterbury, Conn.



38231A

through the coupling impedance. The resistance loading on the circuits is just sufficient to reduce the double peak due to overcoupling at the low frequency end of the range to a satisfactory degree. With the decreased coupling at the higher frequencies the response becomes more rounded.

In designing the r-f circuit, the characteristics of the antenna and transmission lines must be considered. Both impedance matching and loading effects of the transmission line must be taken into account. Also the loading effect of the grid of the detector tube must be considered; this may be considerable at the high frequencies involved. The curves of Fig. 6 were taken with the input properly matched and the detector tube operating.

The impedance in the detector tuned circuit, while it is as large as can be used, is still very low compared to ordinary sound broadcast practice. The thermal agitation (hiss) in this circuit is consequently very low. Most of the hiss in the receiver is therefore caused by the shot effect in the plate circuit of the detector rather than thermal agitation in its grid circuit, as is usual in broadcast receivers. For this reason, great care must be used in choosing the type of tube to be used. Other things being equal, the hiss is a function of the plate current. The gain of the tube is a function of its transconductance. Therefore, a tube having a high ratio of transconductance to plate current should be used so that the signal-to-hiss ratio will be high.

In sound receiver practice it is common to use one or more r-f amplifier stages ahead of the detector. In the case of television the gain possible with conventional receiver tubes is low. For example, with circuits whose wide bandwidth and tuning range reduce their impedance to 1000 ohms or less, a tube with transconductance of, say 2000 micromhos would give a gain of less than two. To make a radio stage feasible, either the circuit impedance must be increased by decreasing either the bandwidth or the tuning range, or a tube of higher than ordinary transconductance must be used. To obtain really effective r-f amplification with present receiving tubes, the tuning range would have to be reduced to where the receiver would tune to

## PLUGS—SOCKETS

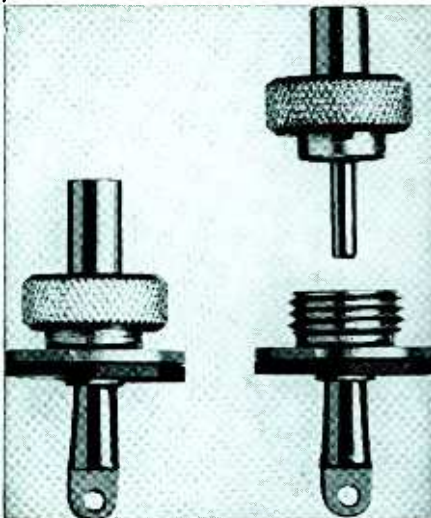

Type No. 101 shielded single contact plug and socket.

One type from our line of several hundred electrical plugs and sockets. We also supply manufacturers with terminal panels, standard or to blueprint.

Write for bulletins on complete line

**HOWARD B. JONES**  
 2300 Wabansia Ave.,  
 Chicago, Ill.

## ACCEPTED



### The VC-1 Beat-Frequency OSCILLATOR

These few months have proven its usefulness in all lines of production and research.

Over 500 Radio and Amplifier Manufacturers, Schools, Laboratories, Police and Broadcast Stations Are Vivid Proof!

Offering Quality Plus at \$37.50 Net  
 Complete with Tubes F.O.B.

### TELEVISO COMPANY

341 N. Pulaski Rd. Chicago, Ill.

Engineering Manufacturers of  
 Allied Electronic Products

EXPORT DEPT.—A. D. AURIEMA, INC.  
 116 BROAD ST., NEW YORK

*Explaining*  
**electron optics theory**  
*and its most useful*  
*application—*

the TELEVISION  
**CATHODE-RAY TUBE**

This new book develops the theory of electron optics from its fundamentals and covers its application in the design of the television cathode-ray tube. The treatment is derived from the authors' first-hand experience with this subject at the research laboratories of the RCA Manufacturing Company.

*Just Out!*

**Electron**  
**Optics**  
**in Television**

By I. G. Maloff  
 and D. W. Epstein

Research Division, RCA Manufacturing Company, Camden, N. J.

299 pages, 6x9, illus., \$3.50



**H**ERE is a book which gives you an understanding of electron optics with applications to problems in pure and applied physics. Here are the basic principles of the design of television cathode-ray tubes and associated circuits.

After a brief description of the complete cathode-ray television system, the book develops the theory of electron emission and electron optics, with particular attention being paid to pure electrostatic lenses, those involving two coaxial cylindrical electrodes.

Part II deals with the problems encountered in designing tubes, practical and economical to construct and capable of producing satisfactory television pictures when used with practical associated apparatus. Included are approximate methods for solving non-linear-circuit problems connected with the design of apparatus associated with the television cathode-ray tube.

**MCGRAW-HILL ON-APPROVAL COUPON**

McGraw-Hill Book Company Inc.  
 330 W. 42nd St., New York, N. Y.

Send me Maloff and Epstein's *Electron Optics in Television* for 10 days' examination on approval. In 10 days I will send \$3.50, plus few cents postage, or return book postpaid. (Postage paid on orders accompanied by remittance.)

Name .....

Address .....

City and State .....

Position .....

Company ..... L. 4-38  
 (Books sent on approval in U. S. and Canada only.)

only a single television station. This would of course greatly impair the usefulness of the receiver. However, using tubes having a transconductance of the order of 5,000 micromhos, a satisfactory and effective radio stage may be designed.\*

Combination oscillator - detector tubes do not oscillate readily at these ultra high frequencies, and their plate current is high and transconductance low. It has been found that a sharp cutoff tube with separate oscillator excitation on its control grid operates very well as a heterodyne detector in a television receiver. To prevent the tube from drawing grid current, and to make the amount of oscillator excitation less critical, self bias on the detector, possibly in combination with AVC bias, has been found very satisfactory. If the detector tuned circuit is coupled to the oscillator circuit in a manner similar to that used in coupling it to the antenna circuit, the oscillator excitation remains reasonably constant over the tuning range.

The tuning unit of Fig. 6 uses two sections of a three-section gang capacitor, with the tuning coils and oscillator tube mounted on the frame of the capacitor. The detector tuned circuit is in the center, so that it is coupled to both the oscillator and antenna circuits. The circuit of the oscillator in this unit, which has been found to be highly satisfactory in performance, is shown in Fig. 7. This circuit is a more or less conventional grid leak biased oscillator, with the feature that the series condenser not only helps make the oscillator frequency track properly with the r-f circuit, but it is also placed in such a position in the circuit that the feedback coupling increases at the low frequency end of the range, due to the increasing ratio of reactance of the series capacitor to that of the tuning capacitor. This desirable effect helps to maintain uniform oscillation strength over the frequency range.

In addition to the requirement that the oscillator furnish uniform excitation to the detector grid circuit there is a rather stringent requirement that it have very small frequency drift. It has been found

\* RCA Radiotron has recently announced a new tube (1851) designed for television purposes. It has a trans-conductance of 9000.—The Editor.

**Compressed Gas**  
**Condenser TYPE 174**



INVESTIGATE these UNIQUE compressed gas condenser ADVANTAGES

FOUR CAPACITIES: 250, 500, 1000 and 1500 mmf.  
 TWO RATINGS . . . 40,000 and 32,000 rms working volts.

CONTROL . . . . . External, continuously variable.

LOSSES . . . . . Lower than equivalent air condensers.

ALSO . . . . . Lower distributed inductance, complete shielding.



**Here's VALUE!**

● Simpson instruments offer you the much desired bridge-type construction with soft iron pole pieces—but without the "bridge-type" prices.

They are built by an organization which includes Ray R. Simpson, formerly president of Jewell Electrical Instrument Co., and a number of the men who once helped him establish the Jewell reputation for precision and ruggedness in electrical instruments.

The new Simpson line includes a wide range of instruments and styles of cases—also finer radio testing equipment. Ask for facts about these remarkable values.

**SIMPSON ELECTRIC CO.**  
 5218 W. Kinzie St. Chicago

**SIMPSON**

*Instruments that STAY accurate*

that a tuned plate oscillator has certain advantages in this respect over a tuned grid oscillator. Circuits which require that both sides of the tuning capacitor be at high r-f potential are undesirable for this particular application for the simple reason that it is more convenient to use a common rotor at ground potential for all three capacitors.

The oscillator frequency is best made higher than that of the incoming carrier so that full advantage can be taken of the tuning range of the radio circuits, and to obtain the advantages of the series capacitors in the oscillator circuit. With identical tuning capacitor and proper series

and parallel trimming capacitor on the oscillator, very accurate tracking of the oscillator with the radio circuits can be obtained over the entire tuning frequency range.

We have now reviewed the fundamental requirements of the antenna, radio frequency selector, oscillator and input portions of the first detector circuit. In terms of the block diagram for the complete receiver shown in Fig. 3, the portions reviewed are shown in Fig. 4. In schematic form, these receiver input circuits are outlined in Fig. 7.

The second article of this series will cover the i-f amplifier circuits for picture and sound.

## Adjudicated Patents

(C. C. A. N. Y.) Lowenstein patent, No. 1,231,764, for telephone-relay claims 1, 2, 4, 5, 6, and 7 *Held* valid and infringed. *Western Electric Co. v. General Talking Pictures Corp.* 91 F. (2d) 922.

(C. C. A. N. Y.) Arnold patent, No. 1,329,283, for thermionic amplifier, claims 7, 10, and 13 *Held* valid. *Id.*

(C. C. A. N. Y.) Arnold patent, No. 1,403,475, for vacuum-tube circuits, claims 8, 9, and 10 *Held* valid and infringed. *Western Electric Co. v. General Talking Pictures Corp.*, 91 F. (2d) 922.

(C. C. A. N. Y.) Pacz patent, No. 1,410,499, for metal and its manufacture, claims 25 to 27 *Held* invalid. *General Electric Co. v. Wabash Appliance Corp.*, 91 F. (2d) 904.

(C. C. A. N. Y.) Mathes patent, No. 1,426,754, for circuits for electron-discharge devices, claim 8 *Held* valid. *Western Electric Co. v. General Talking Pictures Corp.*, 91 F. (2d) 922.

(C. C. A. N. Y.) Arnold patent, No. 1,448,550, for thermionic amplifier circuits, claims 1 and 12 *Held* valid and infringed. *Id.*

(C. C. A. N. Y.) Arnold patent, No. 1,465,332, for vacuum-tube amplifier, (*Low Radio Co.*).

claims 1, 3, 5, 8, 10, and 11 *Held* valid and infringed. *Id.*

(C. C. A. N. Y.) Arnold patent, No. 1,520,994, for electron-discharge amplifier, claims 1 and 4 *Held* valid. *Western Electric Co. v. General Talking Pictures Corp.*, 91 F. (2d) 922.

(C. C. A. Mass.) Mershon patent, No. 1,141,402, for electrolytic apparatus employing filmed electrodes, claim 5 *Held* invalid. *Mershon v. Sprague Specialties Co.*, 92 F. (2d) 313.

(C. C. A. Mass.) Mershon patent, No. 1,784,674, for film formation and operation of electrolytic condensers and other apparatus, claims 10 and 12 *Held* invalid. Claims 5, 8, 13, 14, 15, and 16 *Held* not infringed. *Mershon v. Sprague Specialties Co.*, 92 F. (2d) 313.

1,710,073, 1,714,191, S. Ruben, Electrical condenser, D. C., W. D. N. Y., Doc. 1855, *Ruben Condenser Co. et al. v. N. Abelsob et al. (United Radio Service)*. Dismissed for lack of prosecution Nov. 9, 1937.

1,403,475, H. D. Arnold; 1,403,932, R. H. Wilson; 1,507,016, L. de Forest; 1,507,017, same; 1,618,017, F. Lowenstein; 1,702,833, W. S. Lemmon; 1,811,095, H. J. Round; Re. 18,579, Ballantine & Hull, filed Nov. 10, 1937, D. C., S. D. Calif. (Los Angeles), Doc. E 1279-J, *R. C. A. et al. v. L. Lowenstein*

## MICROHM WIRE WOUND RESISTORS



### TYPE M • 1 WATT • NON-INDUCTIVE ... COMPLETE OR ROUGH WOUND

Available in resistance range from .05 to 500,000 Ohms—as a complete unit of standard accuracy of 1% or rough wound to approximately 3% accuracy. Easily calibrated to requirements.

Mounting through center hole to clear 6/32" screw; terminals hot tinned copper. Full details and prices on request.

### PRECISION RESISTOR COMPANY

332 BADGER AVE.

NEWARK, N. J.

Manufacturers of custom built PRECISION and INDUSTRIAL WIRE WOUND RESISTORS

## PROFESSIONAL SERVICES

*Rates on Application*

### ELECTRICAL TESTING LABORATORIES

Characteristics and  
*Life Tests of Vacuum Tubes*  
Tests of photo cells, glow lamps, crater lamps.  
Tests of electronic and optical devices.  
80th Street and East End Avenue  
New York, N. Y.  
Phone: Butterfield 8-2600

### THAD. R. GOLDSBOROUGH

REGISTERED PATENT ATTORNEY  
*Patent and Trademark Soliciting*  
Consulting Service  
Patent Sale and License Negotiations  
201-205 McLachlen Building  
Washington, D. C.

### INTERNATIONAL ELECTRONICS, INC.

AMERICAN CONSULTING ENGINEERS TO  
FOREIGN MANUFACTURERS

Designs ..... Specifications  
Electrolytics ..... Tubes ..... Resistors  
Transmitters ..... Receivers  
630 Fifth Avenue New York, N. Y.  
Cable:—Interengin, New York

### HAROLD J. McCREARY

Mem. A.I.E.E. & W.S.E.  
**Consulting Engineer**

Research ..... Electronics  
Development ..... Television  
Design ..... Radio  
Factory Practise ..... Railroad Signaling  
Patent Studies ..... Telephony  
105 W. Adams St. Phone STAt 4003 Chicago, Ill.

### RADIO DEVELOPMENT & RESEARCH CORP.

CONSULTANTS AND DESIGNERS

including  
Amplifiers—Antennas—Transmitters  
Receivers—Laboratory Equipment  
Special equipment designed and constructed  
145 West 45th Street, New York, N. Y.  
Tel. BItyant 9-6898

## PROFESSIONAL ASSISTANCE

in the solving of your most difficult problems in the highly specialized field of electronic devices is offered by consultants whose cards appear on this page.



# SEARCHLIGHT SECTION

EMPLOYMENT : BUSINESS : OPPORTUNITIES : EQUIPMENT—USED or RESALE

UNDISPLAYED RATE:  
10 cents a word, minimum charge \$2.00.

Position Wanted, (full or part-time salaried employment only), ½ the above rates, payable in advance.

Proposals, 40 cents a line an insertion.

INFORMATION:

Box Numbers in care of our New York, Chicago, or San Francisco offices count 10 words additional in undisplayed ads. Replies forwarded without extra charge.

Discount of 10% if full payment is made in advance for four consecutive insertions of undisplayed ads (not including proposals).

DISPLAYED—RATE PER INCH:

1 inch.....\$6.00  
2 to 3 inches..... 5.75 an inch  
4 to 7 inches..... 5.50 an inch

An advertising inch is measured vertically on one column, 3 columns—30 inches—to a page. Contract rates on request. (May issue)

(New advertisements must be received by April 22nd for the

## POSITION VACANT

WANTED: Radio tube engineer having several years' practical experience on development and production of coated tungsten heater wire and also full knowledge of cathode coating. Write giving particulars. P-147, Electronics, 330 West 42nd Street, New York City.

## VERTEX

**TRANSLATIONS INTO SPANISH**  
Our translations are clear and understandable because we use the same terms as used by Radio Engineers and Servicemen right in Argentine and all South American Countries. Translations supplied in plain typewriting, cut stencils or printed form. Quick air-mail services. Write for details sending originals when asking for quotations.  
Casilla de Correo 930, Buenos Aires, Argentine

## WANTED

**Small Manufacturer or Individual**  
*one who has shop or manufacturing facilities* and can take small orders for assembling small radio equipment in lots of a dozen at a time. This work can be done by an individual though it will probably lead to quantity work necessitating a factory later on.

BO-146, Electronics  
330 W. 42nd St., New York City

## New "SEARCHLIGHT" Advertisements

must be received by April 22nd to appear in the May issue.

Address copy to the  
Departmental Advertising Staff

Electronics  
330 West 42d St., New York City

Meters repaired, made more serviceable. Conversion to higher sensitivity as high as 10 microamperes for Weston type I or 24-57.

Sensitive vacuum thermo-couples For Sale used Weston panel meters. Rawson microammeters. Brown pyrometers. Reasonable Prices

Precision Electrical Instrument Co.  
561 Broadway, N. Y. C.

## COMPLEX ELECTRONIC DEVICES PLAYING IMPORTANT INDUSTRIAL ROLES

The Altec Service Corporation, an organization composed of scientists, engineers and practical technicians, offers a dependable nation-wide organization for servicing all electronic equipment, such as photo-electric cell

devices, sound transmission apparatus and industrial vacuum tube applications generally. Altec now services 5000 theatres and radio stations. Altec Service Corporation, 250 West 57th Street, New York City.

# ALTEC

SERVICE CORPORATION

## CHAS. EISLER'S

Equipment  
Has Produced

# MILLIONS

750 S. 13th St. (Near Avon Ave.)

## FOREMOST IN THE ELECTRONICS FIELD FOR OVER 20 YEARS!

Charles Eisler's equipment for the production of radio and electronic tubes, incandescent lamps, X-ray and cathode ray tubes, photo-electric cells, mercury switches, and neon signs has met the severest demands of industry in operating at the lowest cost and highest efficiency. If you are in the market for any of this or allied equipment including electric spot welders up to 250 KVA, butt, and arc welders, get in touch with us. Write for our "college and glass working laboratory units" catalog if interested in equipment for instruction purposes.

EISLER ENGINEERING CO. Newark, N. J.

## QUARTZ

Quartz or Glass Apparatus—  
Gaseous Discharge Tubes of all descriptions.

Built to your specifications. We number among our customers America's largest manufacturers of Ultra Violet Equipment.

**HYDE TECHNICAL LABORATORIES**  
1140 Venice Blvd., Los Angeles, Calif.

## DEPENDABLE

New and Used  
**ELECTRONIC TUBE EQUIPMENT**

A complete line of equipment for the manufacture of Radio Tubes, Neon Tubes, Incandescent Lamps, etc.

Write for Bulletin showing savings from 25 to 75%  
**EISLER ELECTRIC CORP.**  
534 39th Street, Union City, N. J.

HIGH GRADE NEW AND USED  
**ELECTRON TUBE EQUIPMENT**

Huge Stock of Equipment of  
Every Type and Variety

**KAHLE ENGINEERING CORPORATION**  
Specialists in Equipment and Methods for the Manufacture of Neon Tubes, Radio Tubes, Incandescent Lamps, Photo Cells, X-ray Tubes, etc.  
941 DeMott St., North Bergen, N. J.

## VACUUM THERMOCOUPLES

Separate Heater and Contact Types,  
Mounted and Unmounted

Ranges from 1 Milliamper and up  
Write for Bulletin "A"

**American Electrical Sales Co. Inc.**  
65-67 E. 8th St., New York, N. Y.

## METERS REPAIRED, TESTED, REBUILT

Specialists on all makes and types

Designers and Manufacturers of  
Special Equipment and Devices  
Used Meters Bought, Sold, Exchanged  
Correspondence invited

**Associated Research, Inc.**  
16 N. May Street CHICAGO, Illinois



E. H. RIETZKE

PRES. OF CREI

# IF

You are an experienced radioman;  
You are ambitious to get ahead rapidly in radio;  
You realize the necessity of a directed training in the engineering principles of radio but are unable to take advantage of college training.—

# Then--

Mail coupon for our new illustrated book "A Tested Plan." It will give you complete details of an advanced home study course in Practical Radio Engineering written for the experienced radioman.

## CAPITOL RADIO ENGINEERING INSTITUTE

Dept. E-4

14th & Park Road—Washington, D. C.  
New York City—29 Broadway

## SOLENOID COUNTERS



New four-wheel counters—1300 ohm 24-48 v. d.c.

These counters have many applications in photo-electric cell work, broadcasting stations, and industrial uses. Original cost \$6.50; while limited stock lasts, \$2.00 each; 3 for \$5.00. C.O.D. only. Perfect cond. guaranteed or money refunded.

**FEDERAL SALES COMPANY**  
26 S. Jefferson St. CHICAGO, ILL.

## IF YOU REQUIRE THE FINEST QUALITY RADIO

METERS  
RESISTORS  
CONDENSERS  
RELAYS

WRITE FOR OUR 1938 CATALOG

# CAMERADIO

963 LIBERTY AVE. • 30 TWELFTH ST.  
PITTSBURGH, PA. WHEELING, W. VA.

Established 1919

## THE MODERN LINE OF "PRECISION"



### ELECTRONOMETER SERIES 700

A complete laboratory of compact size for thorough tube analyzing and point to point set testing that has been endorsed and used by leading engineering concerns, broadcast stations, service organizations and institutions. The Series 700, in addition to modern radio tube analyzing features, also incorporates 22 ranges for measurements of A.C. and D.C. voltages, current, resistance, decibel and output. Accuracy is guaranteed by use of wire wound shunts of 1% tolerance and matched resistors of 1% tolerance

**\$49.95**

### SERIES 840L POPULAR LABORATORY MODEL 22 RANGE MULTI-TESTER

*Designed for Laboratory, Engineering and Production use.*



A.C.-D.C. Volt—Ohm—Decibel—Milliammeter SPECIFICATIONS

- ★ 5 A.C. and D.C. Voltage Ranges from 0 to 2500 volts at 1000 ohms per volt.
- ★ 3 Resistance ranges from 0 to 10 meg-ohms.
- ★ 4 D.C. Current ranges from 0 to 1 ampere.
- ★ 5 Decibel ranges from -10 to plus 63 DB.
- ★ Large 4 1/2" square meter, D'Arsonval type 2% accuracy.
- ★ Wire wound shunts and matched multipliers of 1% tolerance to maintain extreme accuracy.
- ★ Compact in size 9 x 10 x 6.

Net **\$19.95** Less Batteries and Test Leads Price

Write for Catalog 38-E describing the 840 P and other "Precision" test equipment.

**TERMINAL**  
*Radio Corporation*  
80 CORTLANDT STREET, NEW YORK, N. Y.

## INDEX TO ADVERTISERS

Aerovox Corp.....	61
Ad. Auriema, Inc.....	3
Allied Recording Products Co.....	63
American Automatic Electric Co.....	63
American Brass Co.....	64
American Emblem Co.....	58
American Transformer Co.....	42
Amperex Electronics Products, Inc. Inside Front Cover	
Astatic Microphone Laboratory, Inc.....	60
Biddle Co., James G.....	60
Bliley Electric Corp.....	53
Callite Products Division.....	58
Centralab Div., Globe-Union Co.....	47
Cinch Manufacturing Co.....	41
Cinaudagraph Corp.....	53
Driver Co., Wilbur B.....	61
Du Mont Laboratories, Inc., Allen B.....	59
Erie Resistor Corporation.....	46
Ferranti Electric, Inc.....	55
Goat Radio Tube Parts, Inc.....	57
Hardwick-Hindle, Inc.....	60
Heintz & Kaufman, Ltd.....	65
Hunter Pressed Steel Co.....	54
International Nickel Co., Inc.....	7
International Resistance Co.....	33
Isolantite, Inc.....	45
Jones, Howard B.....	64
Leach Relay Co.....	53
Mallory & Sons, P. R.....	8, 34, 35
McGraw-Hill Book Co.....	65
Monarch Mfg. Co.....	68
Ohmite Manufacturing Co.....	62
Pioneer Gen-E-Motor Corp.....	48
Precision Resistor Co.....	66
Presto Recording Corp.....	52
RCA Communications, Inc.....	56
RCA Manufacturing Co.....	Back Cover
Recoton Corp.....	61
Remler Co., Ltd.....	62
Skure Brothers.....	51
Simpson Electric Co.....	65
Sigma Instruments, Inc.....	68
Speer Carbon Co.....	44
Superior Tube Co.....	Inside Back Cover
Synthane Corp.....	43
Televiso Company.....	64
Terminal Radio Corp.....	68
Triplet Electrical Instrument Co.....	51
Ward Leonard Electric Co.....	50
Webster Electric Co.....	5
Western Electric Company.....	6
Weston Elec'l Instrument Corp.....	4
Wilson Co., H. A.....	59
White Dental Mfg. Co., S. S.....	2, 56
Zophar Mills.....	56
Professional Services.....	66
SEARCHLIGHT SECTION Classified Advertising	
EMPLOYMENT.....	67
HOME STUDY COURSE.....	67
QUARTZ OR GLASS APPARATUS.....	67
SERVICE.....	67
EQUIPMENT FOR SALE	
American Electrical Sales Co., Inc.....	67
Associated Research, Inc.....	67
CameRadio Co.....	67
Eisler Electric Corp.....	67
Eisler Engineering Co.....	67
Federal Sales Co.....	67
Kahle Engineering Corp.....	67
Precision Electrical Instrument Co.....	67

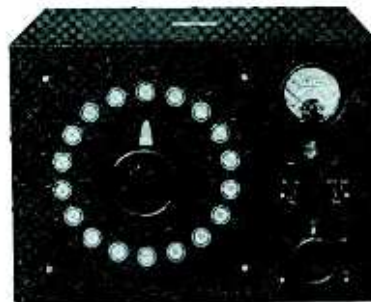

### production — testing

of high accuracy and requiring a minimum of the operator's attention.

- No voltmeter resetting with frequency changes.
- "Passing limit" signal preset at each frequency. Maximum signal 1/10 volt.
- No calibrated slide wires or potentiometers to wear.
- Complete attenuator system for each frequency.
- Terminated output line assures accurate microvoltages to 75 megacycles.

MODEL 18-F GENERATOR \$295.00

**Monarch MANUFACTURING CO.**  
3341 BELMONT AVE., CHICAGO, ILL.  
CABLE ADDRESS "MONMACO"

## RELAYS

BY



### FOR GENERAL ELECTRONIC AND INDUSTRIAL APPLICATIONS

Where a semi-sensitive instrument is required, the Model 2-A relay, operating on only 12 milliwatts D.C. controls 150 watts non-inductive load at 115 volts A.C.

For heavier duty, the Model M relay, operating on 50 milliwatts, controls one kilowatt non-inductive load at 115 volts A.C.

Each of these relays has a single pole, double throw contact circuit, that of the M relay being integral with a Tobe Mu-Switch.

Mounting and connection of SIGMA relays are simultaneously accomplished by plugging the relay base pins into a standard five prong tube socket.

#### LIST PRICES

Model 2-A		Model M	
100 to 2000 ohm fields	\$5.00	\$7.00	
5000 and 8000 ohm fields	\$5.50	\$7.50	

**SIGMA INSTRUMENTS, INC.**  
388 TRAPELO ROAD  
BELMONT, MASSACHUSETTS

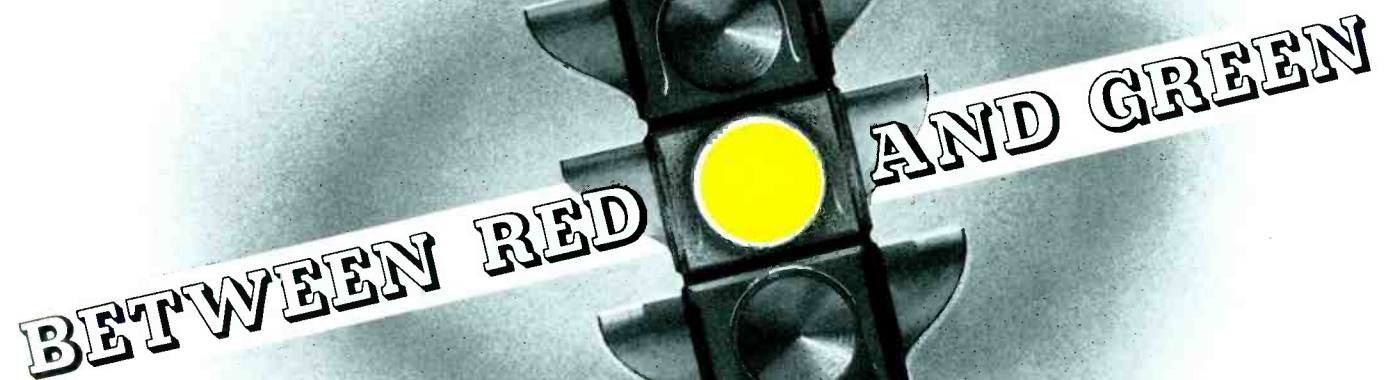

BETWEEN RED AND GREEN

● Like yourselves, probably, we have experienced a brief business period which permitted us sufficient time for further research and development. While the amber light was on we put that waiting moment to good advantage and will shortly announce

### **A New Product**

of vital interest to all users of fine small tubing. Watch for it.

MANUFACTURERS  
of  
Seamless and Lock-  
seam Cathode Sleeves  
and Fine Small Tubing  
in various metals and  
alloys.



**SUPERIOR TUBE COMPANY**  
NORRISTOWN, PENNSYLVANIA

25 MILES FROM PHILADELPHIA

100 MILES FROM NEW YORK

●  
**SUPERIOR TUBING**

*They've got to prove their quality*

**BEFORE WE'LL SELL THEM!**

*—that's why leading manufacturers  
use RCA radio tubes*



### **RCA Quality Control Laboratory "Double-Checks" Tube Tests**

Illustrated above is a scene from Quality Control Laboratory of RCA Radio Tube Factory. In this laboratory, the uniformity and standardized operating characteristics of RCA Radio Tubes are "double-checked" by trained operators whose keen eyes scan sensitive testing machines for any variations in electrical characteristics. This "double-check" test is only one of numerous tests which RCA radio tubes must undergo before being sold. In this laboratory, too, are born many of the methods of improving tube designs for greater efficiency at lower cost.

Your radio sets are no better than the *tubes* you use. You can depend on RCA Radio Tubes. Because their quality is not left to chance. From raw product to finished tube, they're constantly checked and re-checked, so that we'll be sure that you get full value for your money when you buy them!

The *quality* of RCA Radio Tubes is responsible for their overwhelming preference by manufacturers of radio sets.

It's only natural that RCA Radio Tubes are "the tubes of unquestioned quality". Because RCA is better equipped to give you better tubes than any other radio tube manufacturer.

And here's why! RCA engineers—research laboratories—designers—and manufacturing facilities—are without equal. RCA's background for solving difficult problems is unmatched. These are a few of the reasons why RCA is always first with tube developments—developments that assure you of better operating performance at lower cost.

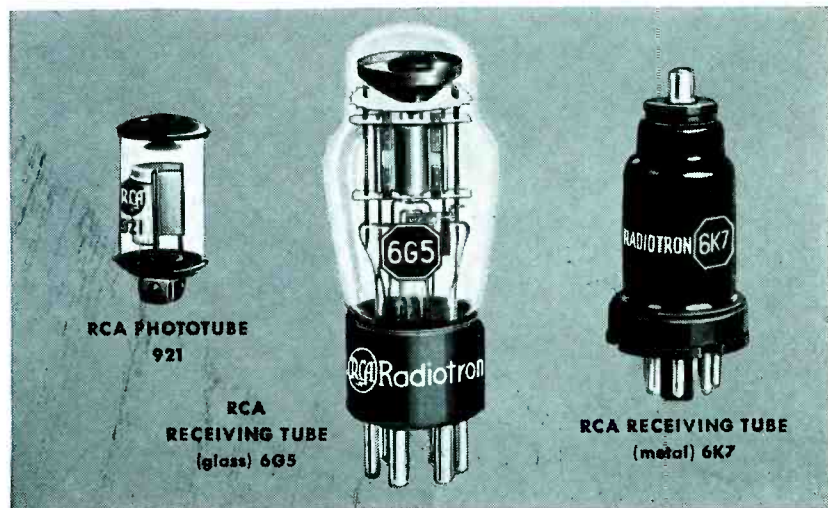

*RCA presents the Magic Key every Sunday, 2 to 3 P.M., E.S.T., on NBC Blue Network*



# *Radio Tubes*

RCA  
MANUFACTURING CO., INC.  
CAMDEN, N. J.

A SERVICE OF THE RADIO CORPORATION OF AMERICA